

Basic Guide

- What Can I Do with This Machine?
- Before Using the Machine
- Document Handling
- Print Media
- Sending Faxes (MF3240 Only)
- Receiving Faxes (MF3240 Only)
- Copying
- Printing
- Scanning
- PC Faxing (MF3240 Only)
- Maintenance
- Troubleshooting
- Machine Settings
- Appendix

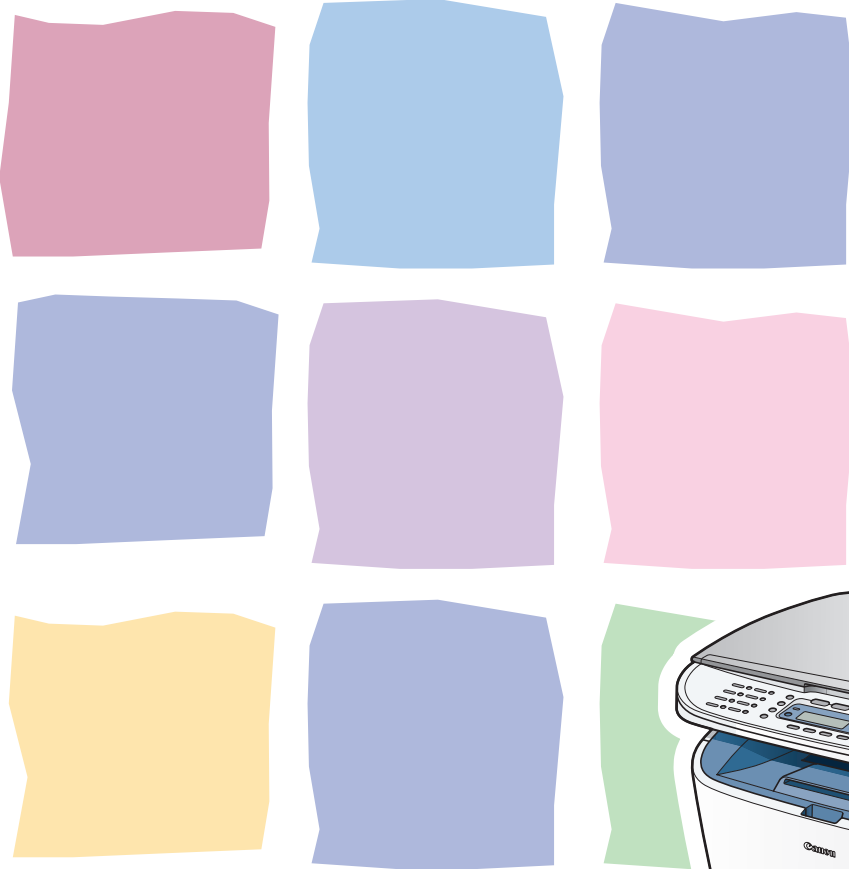

Please read this guide before operating this equipment.
After you finish reading this guide, store it in a safe place for future reference.

Manuals for the Machine

- Machine Set-Up
- Software Installation

Starter Guide

- Basic Features
- Maintenance
- Machine Settings
- Specifications

Basic Guide (This Document)

- Advanced Features
- System Monitor
- Reports and Lists

Advanced Guide



- Printing Features
- Scanning Features
- PC Faxing Features

Software Guide



Indicates the manual is supplied in PDF format in the accompanying CD-ROM.

- To view the manuals in PDF format, Adobe Reader/Adobe Acrobat Reader is required. If Adobe Reader/Adobe Acrobat Reader is not installed on your system, please download it from the Adobe Systems Incorporated website.
- Considerable effort has been made to make sure that the manuals for the machine are free of inaccuracies and omissions. However, as we are constantly improving our products, if you need an exact specification, please contact Canon.
- The machine illustration on the cover may differ slightly from your machine.

What Can I Do with This Machine?

Fax Features (MF3240 Only)

Specify a recipient with a single key

One-Touch Speed Dialing

→ p. 4-7

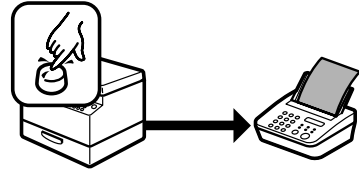

Specify a recipient with a two-digit code

Coded Dialing

→ p. 4-14

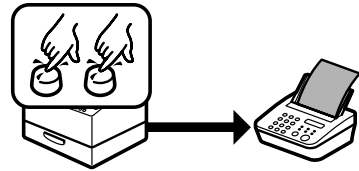

Specify multiple recipients with a single key

Group Dialing

→ p. 4-21

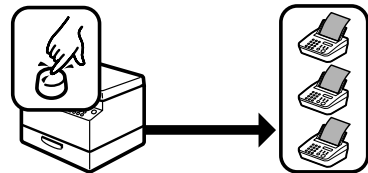

Look up a particular recipient

Address Book Dialing

→ Advanced Guide

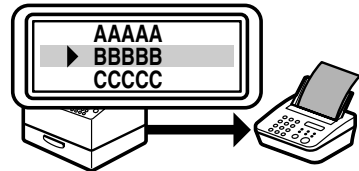

Redial when the line is busy

Redialing

→ Advanced Guide

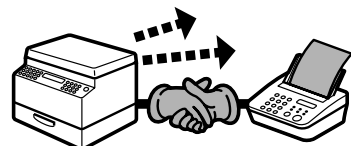

Fax Features (continued)

Send a fax to multiple recipients

Broadcasting

→ Advanced Guide

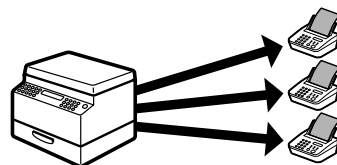

Receive faxes in memory without printing out

Memory Reception

→ Advanced Guide

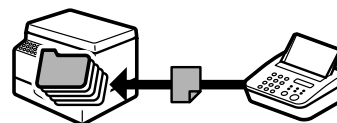

Reject faxes without their numbers

Reception Restriction

→ Advanced Guide

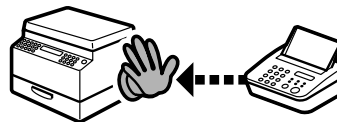

Copy Features

What Can I Do with This Machine?

Select a scan mode depending on the type of image

Image Quality

→ p. 6-3

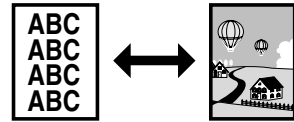

Adjust the density level of scanned images

Density

→ p. 6-4

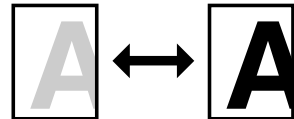

Enlarge or reduce copied images

Zoom Ratio

→ p. 6-6

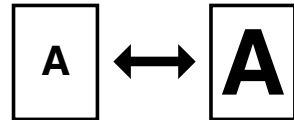

Sorts copies by page order

Collate Copying

→ Advanced Guide

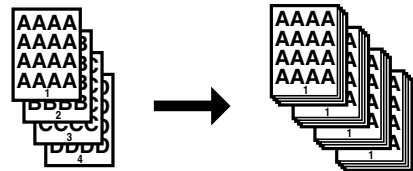

Copy two documents on one sheet

2 on 1 Combination

→ Advanced Guide

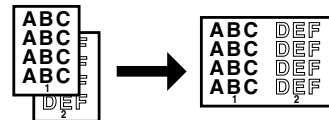

Printer Feature

Print a document from a PC

Printing

→ Software Guide

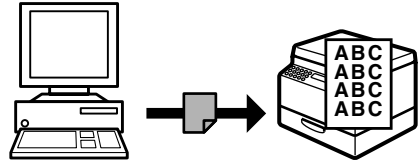

Scanner Feature

Specify detailed scanning options to suit various images

Scanning

→ Software Guide

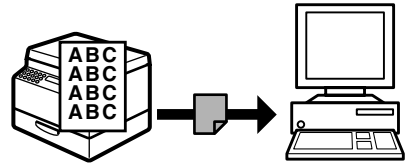

PC Fax Feature (MF3240 Only)

Send a fax from a PC

PC Faxing

→ Software Guide

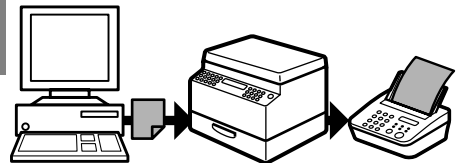

Contents

Manuals for the Machine	i
What Can I Do with This Machine?	ii
Fax Features (MF3240 Only).....	ii
Copy Features	iv
Printer Feature.....	v
Scanner Feature	v
PC Fax Feature (MF3240 Only)	v
Contents	vi
How to Use This Guide	x
Symbols Used in This Manual	x
Illustrations Used in This Manual.....	xi
Legal Notices	xii
Trademarks.....	xii
Copyright	xii
Disclaimer	xii
1 Before Using the Machine	1-1
Machine Components	1-1
Operation Panel	1-3
Main Operation Panel	1-3
Facsimile Operation Panel (MF3240 Only).....	1-6
LCD (Standby Mode)	1-7
Fax Mode (MF3240 Only).....	1-7
Copy Mode	1-7
Scan Mode.....	1-7
Toner Cartridge	1-8
Maintaining the Toner Cartridge	1-9

Timer Settings	1-10
Setting Sleep Mode	1-10
Setting Daylight Saving Time (MF3240 Only).....	1-13
2 Document Handling	2-1
Document Requirements	2-1
Scanning Area	2-2
Loading Documents	2-3
3 Print Media	3-1
Paper Requirements	3-1
Printable Area	3-2
Paper Guidelines	3-3
Loading Paper	3-4
Into the Multi-Purpose Feeder	3-4
Setting Paper Size and Type	3-7
Selecting the Paper Output Area	3-10
Paper Type and Paper Output Area	3-11
Face Down Paper Output Area.....	3-12
Face Up Paper Output Area	3-13
4 Sending Faxes (MF3240 Only)	4-1
Scan Settings	4-3
Image Quality.....	4-3
Density	4-5
Speed Dialing	4-6
Registering Recipients for Speed Dialing	4-6
Using Speed Dialing	4-30

- 5 Receiving Faxes (MF3240 Only)..... 5-1**
- 6 Copying 6-1**
 - Scan Settings..... 6-3**
 - Image Quality..... 6-3
 - Density..... 6-4
 - Zoom Ratio 6-6
- 7 Printing..... 7-1**
- 8 Scanning 8-1**
- 9 PC Faxing (MF3240 Only) 9-1**
- 10 Maintenance..... 10-1**
 - Cleaning the Machine..... 10-1**
 - Exterior 10-1
 - Interior..... 10-2
 - Scanning area..... 10-4
 - Replacing the Toner Cartridge 10-5**
 - Redistributing Toner 10-5
 - Replacing the Toner Cartridge with a New One 10-6
 - Transporting the Machine..... 10-9**
- 11 Troubleshooting 11-1**
 - Clearing Paper Jams 11-1**
 - LCD Messages 11-7**
 - Common 11-7
 - Facsimile (MF3240 Only)..... 11-11
 - Printer 11-14
 - Error Codes (MF3240 Only) 11-15**
 - If You Cannot Solve a Problem 11-16**

12 Machine Settings	12-1
Machine Settings	12-1
Printing User's Data List (MF3240 Only)	12-1
Accessing the Setting Menu	12-3
Setting Menu	12-5
COMMON SETTINGS	12-5
COPY SETTINGS	12-6
TIMER SETTINGS	12-7
FAX SETTINGS (MF3240 Only)	12-7
BROADCAST (MF3240 Only)	12-11
ADDRESS BOOK SET. (MF3240 Only)	12-11
REPORT SETTINGS (MF3240 Only)	12-12
13 Appendix	13-1
Specifications	13-1
General	13-1
Copier	13-3
Printer	13-3
Facsimile (MF3240 Only).....	13-4
Telephone (MF3240 Only).....	13-5
Index	13-6

How to Use This Guide

Symbols Used in This Manual

The following symbols are used throughout the manuals for the machine and indicate the warnings, cautions and notes you should keep in mind when using the machine.



WARNING

Indicates a warning that may lead to death or serious injury if not observed.



CAUTION

Explains how to avoid actions that could injure you or damage your machine.



NOTE

Explains operating restrictions and how to avoid minor difficulties.

In addition, this guide uses distinctive notations to identify keys and information in the LCD:

- The keys you press appear in square brackets: [Stop/Reset].
- Information in the LCD appears in angle brackets: <LOAD PAPER>.

The numbers that point to the keys on the operation panel diagram correspond to the order of steps to take in the procedure.

Illustrations Used in This Manual

Unless otherwise mentioned, illustrations used in this manual are those taken from the imageCLASS MF3240.



When there is any difference between MF3240 and MF3222, it is clearly indicated in the text, e.g., “MF3240 Only.”

Legal Notices

Trademarks

Canon, the Canon logo, and imageCLASS are trademarks of Canon Inc. All other product and brand names are registered trademarks, trademarks or service marks of their respective owners.

Copyright

Copyright © 2006 by Canon Inc. All rights reserved. No part of this publication may be reproduced, transmitted, transcribed, stored in a retrieval system, or translated into any language or computer language in any form or by any means, electronic, mechanical, magnetic, optical, chemical, manual, or otherwise, without the prior written permission of Canon Inc.

Disclaimer

The information in this document is subject to change without notice. CANON INC. MAKES NO WARRANTY OF ANY KIND WITH REGARD TO THIS MATERIAL, EITHER EXPRESS OR IMPLIED, EXCEPT AS PROVIDED HEREIN, INCLUDING WITHOUT LIMITATION, THEREOF, WARRANTIES AS TO MARKETABILITY, MERCHANTABILITY, FITNESS FOR A PARTICULAR PURPOSE OF USE OR AGAINST INFRINGEMENT OF ANY PATENT. CANON INC. SHALL NOT BE LIABLE FOR ANY DIRECT, INCIDENTAL, OR CONSEQUENTIAL DAMAGES OF ANY NATURE, OR LOSSES OR EXPENSES RESULTING FROM THE USE OF THIS MATERIAL.

1

Before Using the Machine

Machine Components

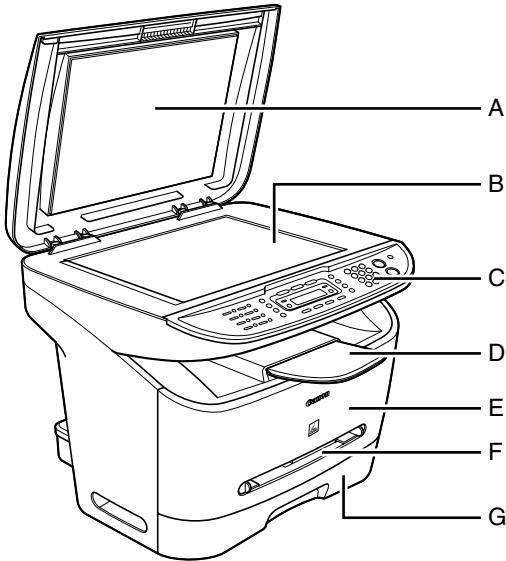

- A Platen glass cover
Open this cover when placing a document on the platen glass.
- B Platen glass
Place documents.
- C Operation panel
Controls the machine.
- D Output tray
Outputs printouts.
- E Front cover
Open this cover when installing the toner cartridge or clearing paper jams.
- F Multi-purpose feeder
Feeds paper when you insert one by one manually.
- G Paper cassette
Holds the paper supply.

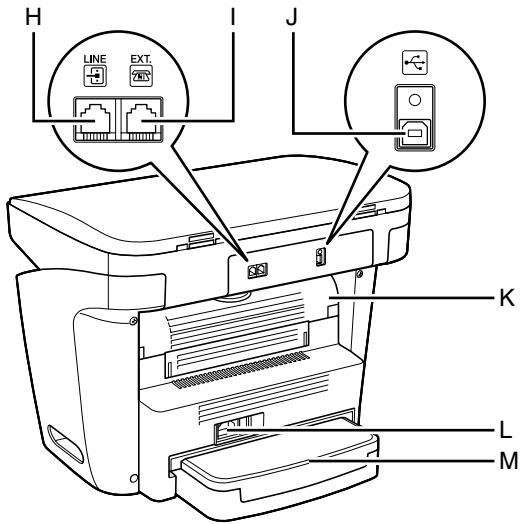

- H* Telephone line jack
Connect the telephone cable.
- I* External device jack
Connect an external device.
- J USB port
Connect the USB (Universal Serial Bus) cable.
- K Face up cover
Open this cover when outputting paper face up or clearing paper jams.
- L Power socket
Connect the power cord.
- M Extension cover
Protects paper supply in the paper cassette from dirt and dust.

*MF3240 Only

Operation Panel

Main Operation Panel

● MF3240

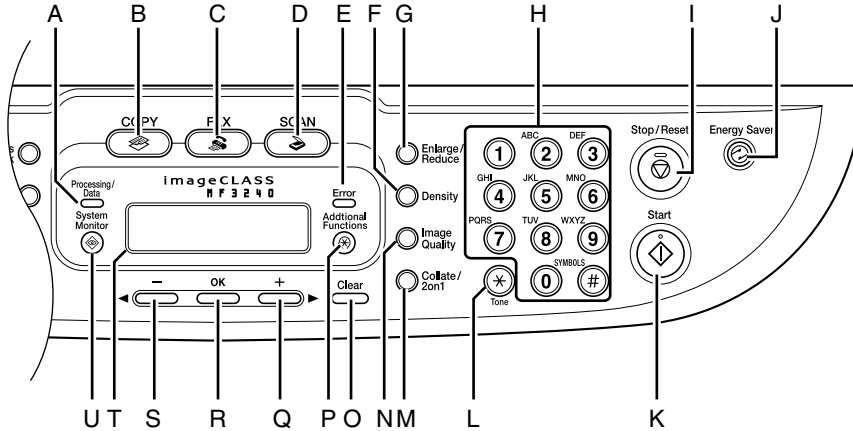

- | | |
|--|--|
| <p>A Processing/Data indicator
Flashes during sending or receiving faxes.
Lights when the machine has waiting jobs.</p> <p>B [COPY] key
Press to switch to Copy mode.</p> <p>C [FAX] key
Press to switch to Fax mode.</p> <p>D [SCAN] key
Press to switch to Scan mode.</p> <p>E Error indicator
Flashes when an error has occurred.</p> <p>F [Density] key
Press to adjust copy or fax density.</p> | <p>G [Enlarge/Reduce] key
Press to enlarge or reduce copy ratio.</p> <p>H Numeric keys
Enter letters and numbers.</p> <p>I [Stop/Reset] key
Press to stop a current job. Also, press to return the machine to standby mode.</p> <p>J [Energy Saver] key
Press to set or cancel Sleep mode manually. The key lights green when Sleep mode is set, and goes off when the mode is canceled.</p> <p>K [Start] key
Press to start copying, scanning and sending faxes.</p> |
|--|--|

- L [Tone] key
Press to switch from rotary pulse to tone dialing.
- M [Collate/2 on 1] key
Press to collate copies, or press to set 2 on 1 copying.
- N [Image Quality] key
Press to select image quality for copy or fax.
- O [Clear] key
Press to clear entered alphanumeric characters.
- P [Additional Functions] key
Press to select or cancel modes in Additional Functions.
- Q [+▶] key
Press to increase the value for various settings. Also press to see the next item in the menu.
- R [OK] key
Press to accept a set function or mode.
- S [◀-] key
Press to decrease the value for various settings. Also press to see the previous item in the menu.
- T LCD display
Displays messages and prompts during operation. Displays selection, text, and numbers when adjusting the settings.
- U [System Monitor] key
Press to check print status, fax status, print and scan counts, remaining memory, or print transmission/reception results.

● MF3222

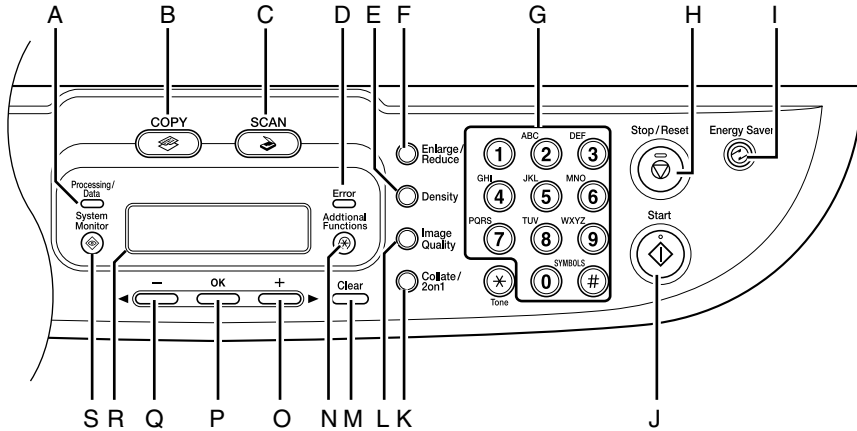

- | | |
|--|--|
| <p>A Processing/Data indicator
Lights when the machine has waiting jobs.</p> <p>B [COPY] key
Press to switch to Copy mode.</p> <p>C [SCAN] key
Press to switch to SCAN mode.</p> <p>D Error indicator
Flashes when an error has occurred.</p> <p>E [Density] key
Press to adjust copy density.</p> <p>F [Enlarge/Reduce] key
Press to enlarge or reduce copy ratio.</p> <p>G Numeric keys
Press to enter numbers.</p> <p>H [Stop/Reset] key
Press to stop a current job. Also, press to return the machine to standby mode.</p> <p>I [Energy Saver] key
Press to set or cancel Sleep mode manually. The key lights green when Sleep mode is set, and goes off when the mode is canceled.</p> <p>J [Start] key
Press to start copying and scanning.</p> <p>K [Collate/2 on 1] key
Press to collate copies, or press to set 2 on 1 copying.</p> | <p>L [Image Quality] key
Press to select image quality for copy.</p> <p>M [Clear] key
Press to clear entered alphanumeric characters.</p> <p>N [Additional Functions] key
Press to select or cancel modes in Additional Functions.</p> <p>O [+▶] key
Press to increase the value for various settings. Also press to see the next item in the menu.</p> <p>P [OK] key
Press to accept a set function or mode.</p> <p>Q [◀-] key
Press to decrease the value for various settings. Also press to see the previous item in the menu.</p> <p>R LCD display
Displays messages and prompts during operation. Displays selection, text, and numbers when adjusting the settings.</p> <p>S [System Monitor] key
Press to check print status, print and scan counts.</p> |
|--|--|

Facsimile Operation Panel (MF3240 Only)

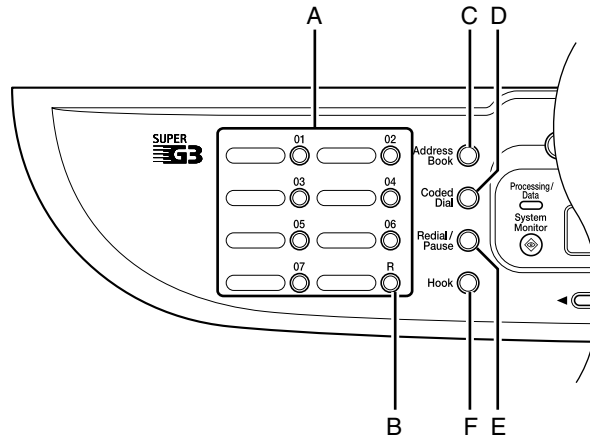

- A** One-Touch Speed Dial keys
Press to use one-touch speed dialing (Pre-registered frequently used numbers) or Group Dialing.
- B** [R] key
Press to dial an outside line access number or an extension number when the unit is connected through a switchboard (PBX).
- C** [Address Book] key
Press to search pre-registered destinations under one-touch speed dialing keys or coded dialing numbers by name.
- D** [Coded Dial] key
Press to perform coded dialing.
- E** [Redial/Pause] key
Press to redial the last dialed number when fax is standing by, or press to insert a pause when entering a fax number.
- F** [Hook] key
Press when you want to dial without lifting up the handset of the external telephone.

LCD (Standby Mode)

Fax Mode*

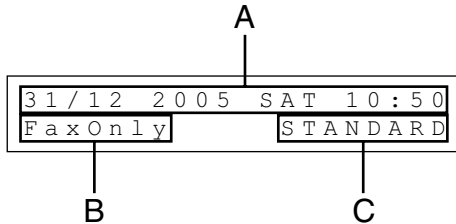

- A Date & Time
- B Receive mode
- C Image quality

* MF3240 Only

Copy Mode

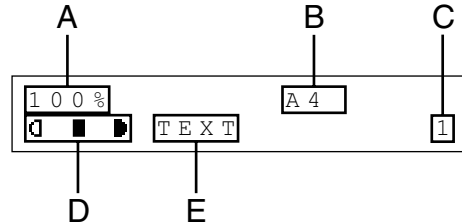

- A Zoom ratio
- B Paper size
- C Quantity
- D Density
- E Image quality

Scan Mode



NOTE

- When the machine is plugged in, the LCD displays <PLEASE WAIT> first, and then displays <INITIALIZING...> until standby display appears. It is also possible to see standby display without having <INITIALIZING...> shown.
- If the machine remains idle for one minute, the display returns to standby mode (Auto Clear Function).

Toner Cartridge

The lifetime of the Canon Genuine starter toner cartridge which comes with the machine is approximately 1,500 pages, the Canon genuine replacement toner cartridge is approximately 2,500 pages. The page counts are on the basis of “ISO/IEC 19752”* when printing A4 size paper with the default print density setting. The level of toner consumption varies depending on the type of documents printed. If your average document contains a lot of graphics, tables, or charts, the life of the toner cartridge will be shorter as they consume more toner. To purchase the Canon genuine replacement toner cartridge, contact your local authorized Canon dealer or the Canon help line.

* “ISO/IEC 19752” is the global standard related to “Method for the determination of toner cartridge yield for monochromatic electrophotographic printers and multi-function devices that may contain printer components” issued by ISO (International Organization for Standardization).

**Toner Cartridge name:
Canon Cartridge U**

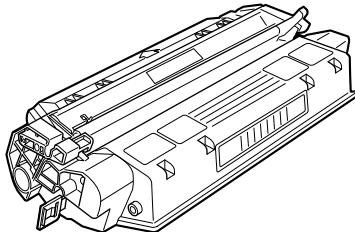

Model Name	Type	Supported Canon Genuine Cartridge	Print Yield
MF3240 MF3222	Bundled	Canon Cartridge U Starter	Approx. 1,500 pages (A4)
	Replacement	Canon Cartridge U	Approx. 2,500 pages (A4)

Maintaining the Toner Cartridge

- Keep the toner cartridge away from computer screens, disk drives, and floppy disks. The magnet inside the toner cartridge may harm these items.
- Avoid locations subject to high temperature, high humidity, or rapid changes in temperature.
- Do not expose the toner cartridge to direct sunlight or bright light for more than five minutes.
- Store the toner cartridge in its protective bag. Do not open the bag until you are ready to install the toner cartridge in the machine.
- Save the toner cartridge's protective bag in case you need to repack and transport the toner cartridge at a later date.
- Do not store the toner cartridge in a salty atmosphere or where there are corrosive gases such as from aerosol sprays.
- Do not remove the toner cartridge from the machine unnecessarily.
- Do not open the drum protective shutter on the toner cartridge. Print quality may deteriorate if the drum surface is exposed to light or is damaged.
- Always hold the toner cartridge by its handle to avoid touching the drum protective shutter.
- Do not stand the toner cartridge on end, and do not turn it upside down. If toner becomes caked in the toner cartridge, it may become impossible to free it even by shaking the toner cartridge.

CAUTION

Do not place the toner cartridge in fire. Toner powder is flammable.

Timer Settings

Setting Sleep Mode

When the machine remains idle for a certain period of time, it automatically enters Sleep mode.

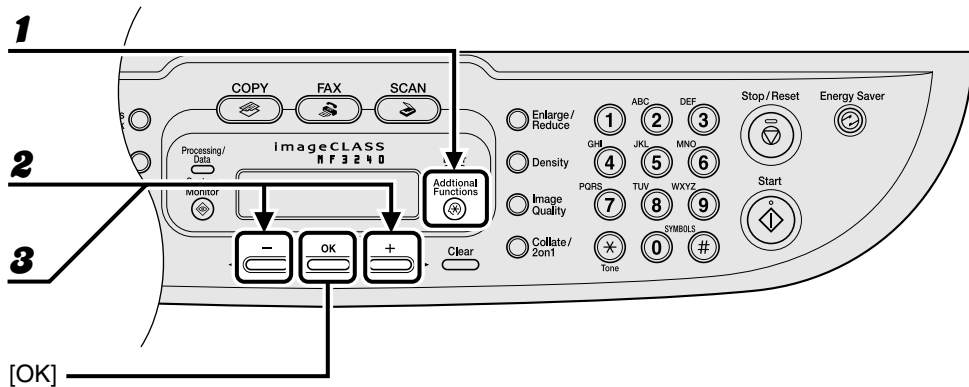

- 1** Press [Additional Functions].
- 2** Press [←] or [→] to select <TIMER SETTINGS>, then press [OK].
- 3** Press [←] or [→] to select <AUTO SLEEP>, then press [OK].



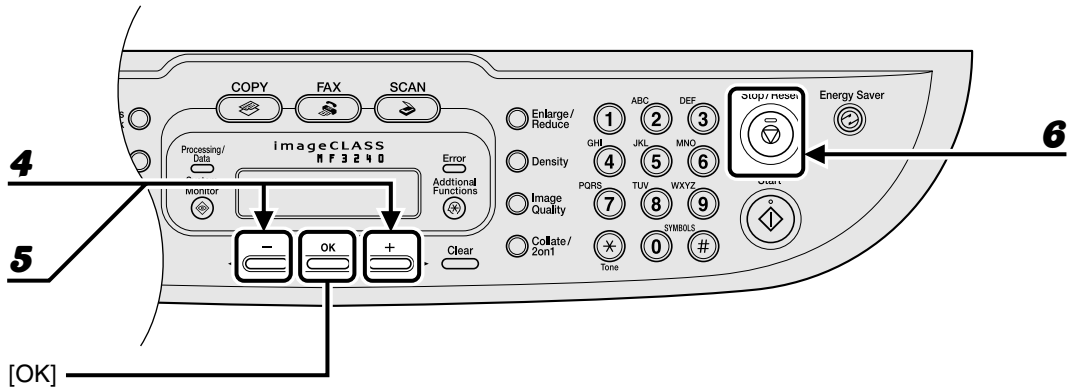

- 4** Press [**←**] or [**→**] to select <ON>, then press [OK].
- 5** Press [**←**] or [**→**] to select the desired interval, then press [OK].
You can set the interval from 3 to 30 minutes (in one-minute increments).
You can also enter values with the numeric keys.
- 6** Press [Stop/Reset] to return to standby mode.

 **NOTE**

- To resume normal mode from Sleep mode, press [Energy Saver] on the operation panel.
- To enter Sleep mode manually, press [Energy Saver] on the operation panel.
- The machine will not enter Sleep mode when:
 - the machine is in operation
 - the Processing/Data indicator lights or flashes
 - an error code or message appears on the display and the Error indicator flashes
 - no paper is loaded in the paper cassette
 - paper is loaded in the multi-purpose feeder
 - a paper jam occurs in the machine
- The machine will leave Sleep mode when:
 - you press [Energy Saver] on the operation panel
 - a fax is received
 - the handset of the external telephone is off the hook
 - a print job is sent from a computer, and the print is started

Setting Daylight Saving Time (MF3240 Only)

In some countries or areas, time is advanced throughout the summer season. This is called “Daylight Saving Time.”

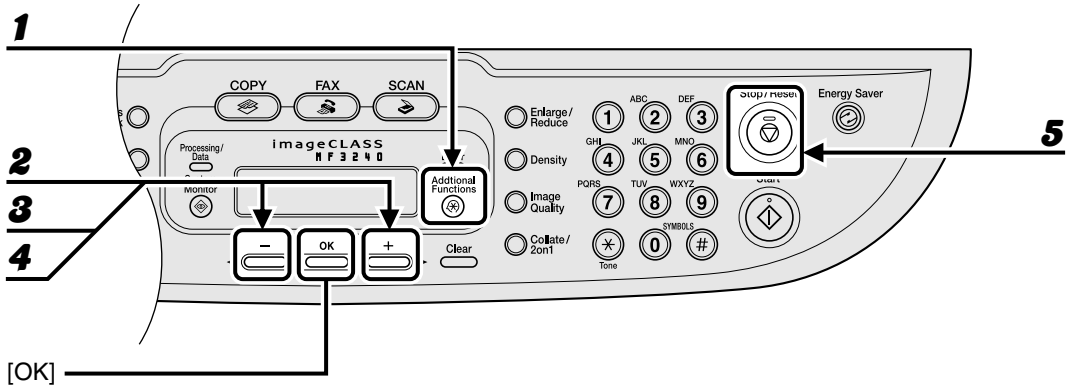

- 1** Press [Additional Functions].
- 2** Press [◀] or [▶] to select <TIMER SETTINGS>, then press [OK].
- 3** Press [◀] or [▶] to select <DAYLIGHT SV.TIME>, then press [OK].
- 4** Press [◀] or [▶] to select <ON>, then press [OK].
- 5** Press [Stop/Reset] to return to standby mode.

2

Document Handling

Document Requirements

Type	<ul style="list-style-type: none">– Plain paper– Thick documents– Photographs– Small documents (e.g., index cards)– Special types of paper (e.g., tracing paper*, transparencies*, etc.)– Book (Height: max. 35 mm)
------	--

Size (W × L)	Max. 216 × 297 mm
--------------	-------------------

Weight	Max. 2 kg
--------	-----------

Quantity	1 sheet
----------	---------

* When copying a transparent document such as tracing paper or transparencies, use a piece of plain white paper to cover the document after placing it face-down on the platen glass.

 **NOTE**

Do not place the document on the platen glass until the glue, ink or correction fluid on the document is completely dry.

Scanning Area

Make sure your document's text and graphics fall within the shaded area in the following diagram. Note that the margin widths listed are approximate and there may be slight variations in actual use.

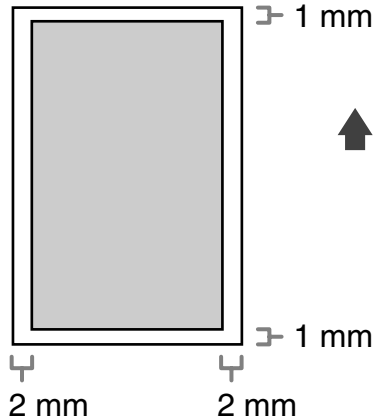

Loading Documents

- 1** Lift up the platen glass cover.

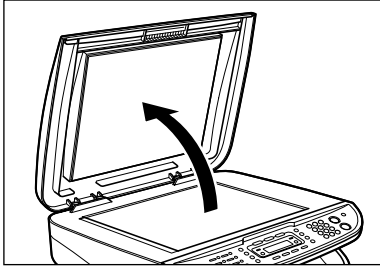

- 2** Place your document face down.

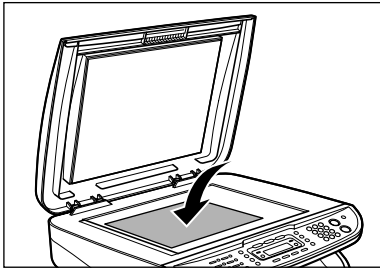

3 Align the document with the appropriate paper size marks.



If your document does not match any of the paper size marks, align the center of your document with the arrow mark.

4 Gently close the platen glass cover.

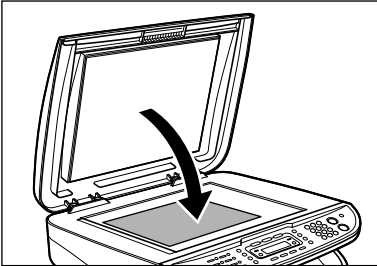

The document is ready for scanning.

⚠ CAUTION

- When closing the platen glass cover, be careful not to get your fingers caught, as this may result in personal injury.
- Do not press down the platen glass cover forcefully, as this may damage the platen glass and cause personal injury.

📌 NOTE

Remove the document from the platen glass when scanning is complete.

3 Print Media

Paper Requirements

	Paper cassette	Multi-purpose feeder
Size (W × L)	A4, B5, A5, Executive, Envelope (COM10, Monarch, DL, ISO-C5), LTR (76 × 127 to 216 × 356 mm)	A4, B5, A5, Executive, Envelope (COM10, Monarch, DL, ISOC5), LTR, LGL (76 × 127 to 216 × 356 mm)
Weight	64 to 128 g/m ²	64 to 163 g/m ²
Quantity	Max. 250 sheets (64 g/m ²)	Max. 1 sheet (64 g/m ²)
Type	Plain Paper, Plain Paper L, Heavy Paper, Heavy Paper H, Transparency	

 **NOTE**

The default paper size is A4. If you use a different paper size, you must change the paper size settings. (See “Setting Paper Size and Type,” on p. 3-7.)

Printable Area

The shaded area indicates the approximate printable area of A4-size paper and envelope.

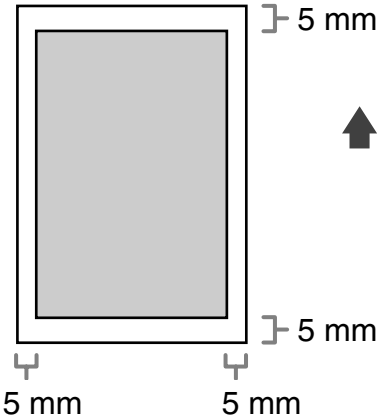

Paper Guidelines

- To prevent paper jams, do not use any of the following:
 - Wrinkled or creased paper
 - Curled or rolled paper
 - Coated paper
 - Torn paper
 - Damp paper
 - Very thin paper
 - Paper which has been printed on using a thermal transfer printer (Do not copy on the reverse side.)
- The following types of paper do not print well:
 - Highly textured paper
 - Very smooth paper
 - Shiny paper
- Make sure the paper is free from dust, lint, and oil stains.
- Be sure to test paper before purchasing large quantities.
- Store all paper wrapped and on a flat surface until ready for use. Keep opened packs in their original packaging in a cool, dry location.
- Store paper at 18°C-24°C, 40%-60% relative humidity.
- Use only the transparencies designed for laser printers. Canon recommends you to use Canon type transparencies with this machine.

Loading Paper

To load paper in the paper cassette, see “Set Up the Paper Cassette and Load Paper,” in the Starter Guide.

Into the Multi-Purpose Feeder

Use the multi-purpose feeder when you want to copy or print on the different paper which is in the paper cassette. Load paper one by one in the multi-purpose feeder.

NOTE

- The paper in the multi-purpose feeder is fed prior to the paper in the paper cassette.
- The recommended envelopes are COM10, MONARCH, DL, and ISO-C5. Using other envelopes may affect the quality of the printout.
- Make sure to set the correct paper size in the printer driver. (See the Software Guide.)
- When printing received documents, it is possible to feed paper only from the paper cassette. If paper is loaded into the multi-purpose feeder, <REMOVE MP PAPER> appears.

1 Slide the paper guides to the mark of the desired paper size.

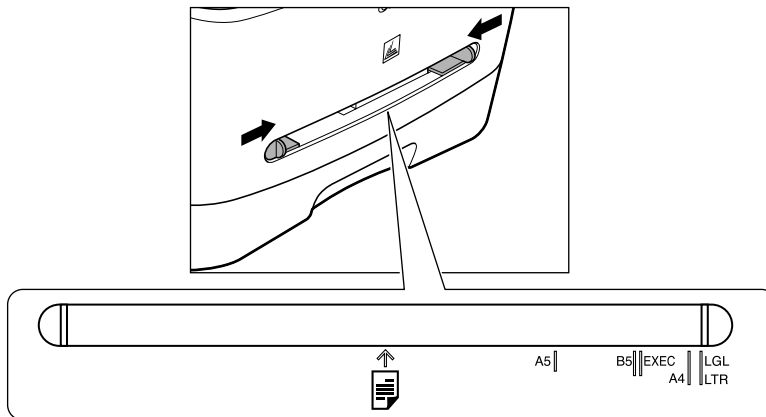

NOTE

If the paper guides are not adjusted correctly for the size of the paper, the quality of your printouts may be adversely affected.

- 2** When setting a paper, insert the paper into the multi-purpose feeder with the print side up.

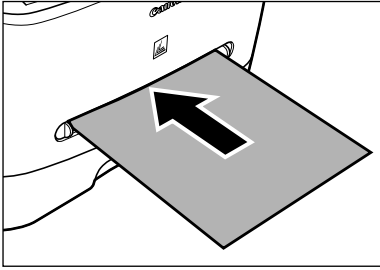

NOTE

When you load paper with a logo on, position the paper with the print side up (logo side) and insert it so that the top of the paper feeds first in the multi-purpose feeder.

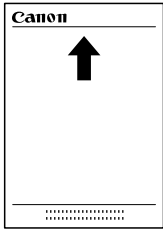

When setting an envelope, insert the envelope into the multi-purpose feeder with the print side up and the right edge (i.e., closer to the stamp) first.

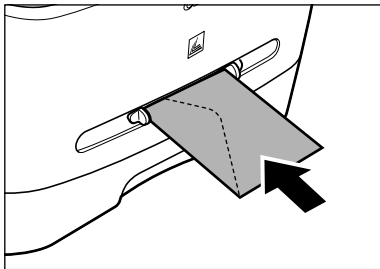

3 Specify the size and the type of the paper you load.

For details on how to specify the paper size and type, see “Setting Paper Size and Type,” on p. 3-7.

Setting Paper Size and Type

The default setting is <A4> and <PLAIN PAPER>. When you place other sizes and/or types of paper, follow this procedure to change the settings.

The procedure is same for the paper cassette and multi-purpose feeder except for selecting the paper cassette or multi-purpose feeder in step 4 and 7.

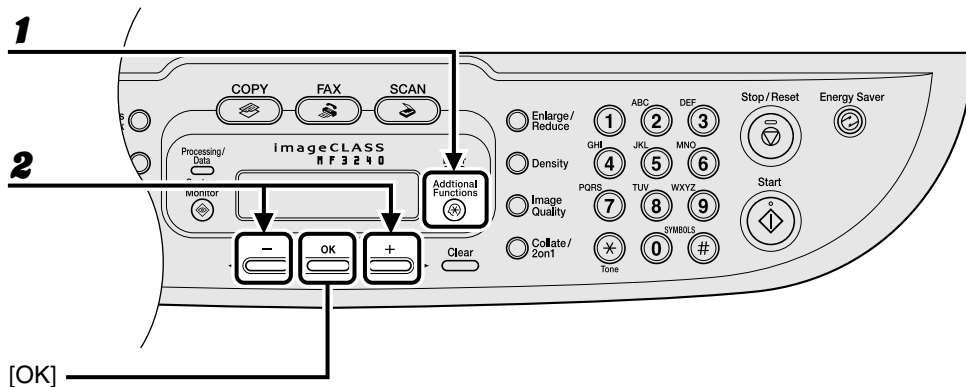

- 1** Press [Additional Functions].
- 2** Press [←] or [→] to select <COMMON SETTINGS>, then press [OK].

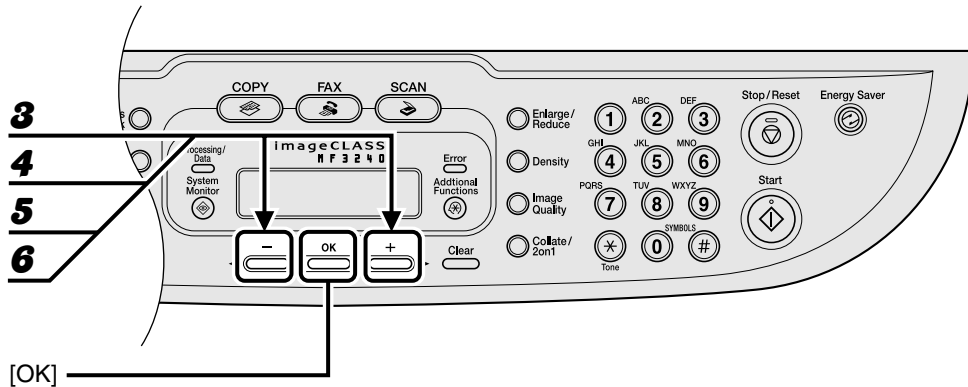

[OK]

- 3** Press [**←**] or [**→**] to select <PAPER SETTINGS>, then press [OK].
- 4** Press [**←**] or [**→**] to select <CASSETTE> or <MP TRAY>, then press [OK].
- 5** Press [**←**] or [**→**] to select <PAPER SIZE>, then press [OK].
- 6** Press [**←**] or [**→**] to select the paper size, then press [OK].

<A4>, <B5>, <A5>, <EXECUTIVE>, <COM10>, <MONARCH>, <DL>, <ISO-C5>, <LTR>, <LGL>*

*Multi-purpose feeder Only

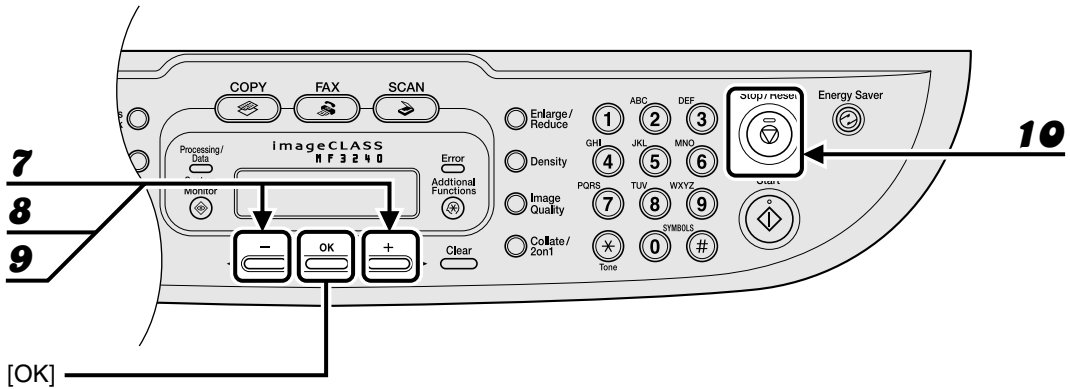

- 7** Press [**←**] or [**→**] to select <CASSETTE> or <MP TRAY>, then press [OK].
- 8** Press [**←**] or [**→**] to select <PAPER TYPE>, then press [OK].
- 9** Press [**←**] or [**→**] to select the paper type, then press [OK].

You can select from the following paper types:

<PLAIN PAPER> or <PLAIN PAPER L>^{*1} for Plain paper (64 g/m² to 90 g/m²)

<HEAVY PAPER> or <HEAVY PAPER H>^{*2} for Heavy paper (105 g/m² to 128 g/m²) or Envelope

<TRANSPARENCY> for Transparency

^{*1} If paper curls excessively when printed with <PLAIN PAPER> selected, select <PLAIN PAPER L>.

^{*2} If print fixing is not sufficient when printed with <HEAVY PAPER> selected, select <HEAVY PAPER H>.

- 10** Press [Stop/Reset] to return to standby mode.

Selecting the Paper Output Area

Open the face up cover located on back side of the unit for face up paper output, or close the face up cover and attach the output tray on the front of the unit for face down paper output.

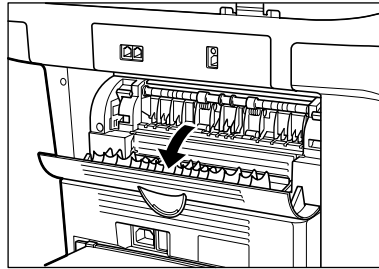

 **NOTE**

Do not open or close the face up cover while copying and printing.

Face down paper output delivers paper with the printed side down on the output tray.
Face up paper output delivers paper with the printed side up from the output area.
Select the area depending on your purpose by opening or closing the face up cover.

Paper Type and Paper Output Area

Select the suitable paper output area depending on the paper type and your purpose.

Paper Type	Paper Output Area	The Number of Output Sheets
Plain Paper	face up	1 sheet
	face down	approx. 60 sheets (64 to 90 g/m ²)
Plain Paper L	face up	1 sheet
	face down	approx. 30 sheets (64 to 90 g/m ²)
Heavy Paper	face up	1 sheet
	face down	approx. 30 sheets (105 to 128 g/m ²)
Heavy Paper H	face up	1 sheet
	face down	approx. 30 sheets (105 to 128 g/m ²)
Transparencies	face up	1 sheet
	face down	10 sheets

Face Down Paper Output Area

The paper is delivered with the printed side down on the output tray.
Paper is stacked in printed order.

- 1** Close the face up cover, and attach the output tray.

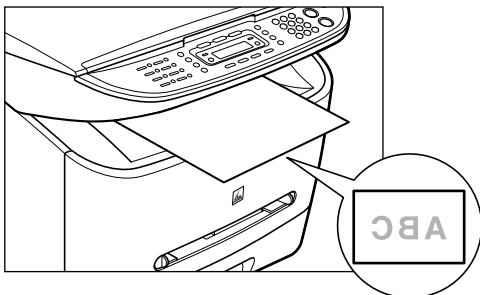

 **NOTE**

- Do not place the delivered paper back on the output tray. Doing so may result in paper jams.
- Do not place objects other than paper on the output tray. Doing so may result in paper jams.

Face Up Paper Output Area

The paper is delivered with the printed side up from the face up paper output area at the rear of the machine.

This way is convenient for printing on transparencies, or envelopes which tend to curl, because the paper is delivered straight through out of the machine.

1 Open the face up cover.

Remove the delivered paper one by one.

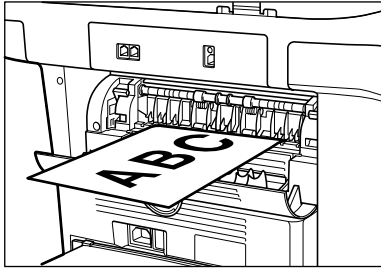

NOTE

- Do not pull the paper forcibly.
- This machine has no face up output tray. Remove the delivered paper with your hand.
- Do not place an object in front of the face up paper output area to prevent a paper jam.

4

Sending Faxes

(MF3240 Only)

Follow this procedure to send a fax.

1 Set a Document

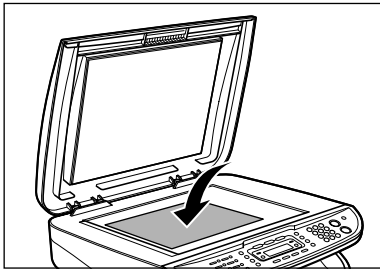

Place the document on the platen glass.

For documents you can fax, see "Document Requirements," on p. 2-1.

2 Enter the Fax Mode

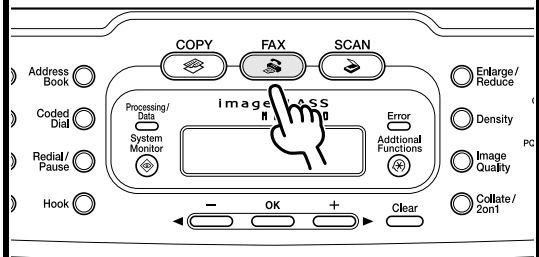

Press [FAX].

The FAX indicator lights and the machine enters fax standby mode.

What if...

- **You want to adjust the resolution and density:**
See "Scan Settings," on p. 4-3.

3 Enter the Fax Number

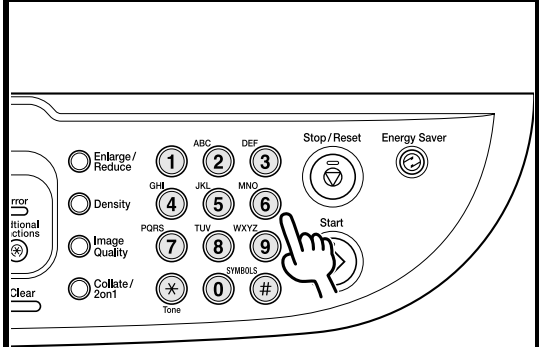

Dial the recipient's fax number with the numeric keys.

Ex.

☎ = 0 1 2 X X X X X X X _

What if...

- **You enter a wrong number:**
Go back to the wrong digit with [←], then press [Clear] to delete it. Or press and hold [Clear] to delete the entire entry. Then try again.

4 Send the Document

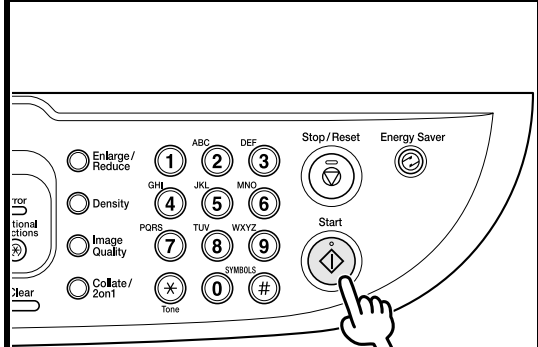

Press [Start]. After all scanning is complete, press [OK] to start dialing.

If the output paper in the recipient's machine is not equal to the scanned size, the original image may be reduced in size or divided into smaller parts when it is received.

What if...

- **You press [Stop/Reset] to cancel a job during scanning documents or after scanning documents:**
The <CANCEL DURING TX/RX?> message appears. Press [←] to select <Yes>. The job is canceled, and the display returns to standby mode.

Scan Settings

You can adjust the image quality and density of the document you send. The higher image quality you set, the better the output will be, but the longer the transmission will take. Adjust the scan settings according to the type of document you are sending.

Image Quality

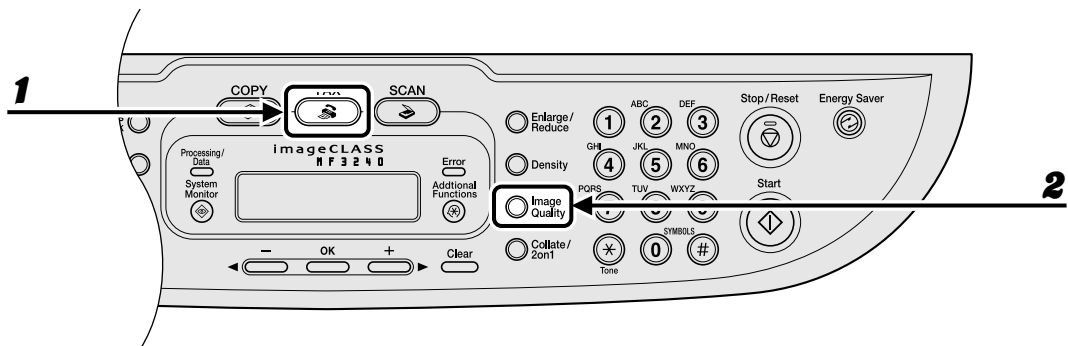

1 Press [FAX].

2 Press [Image Quality].

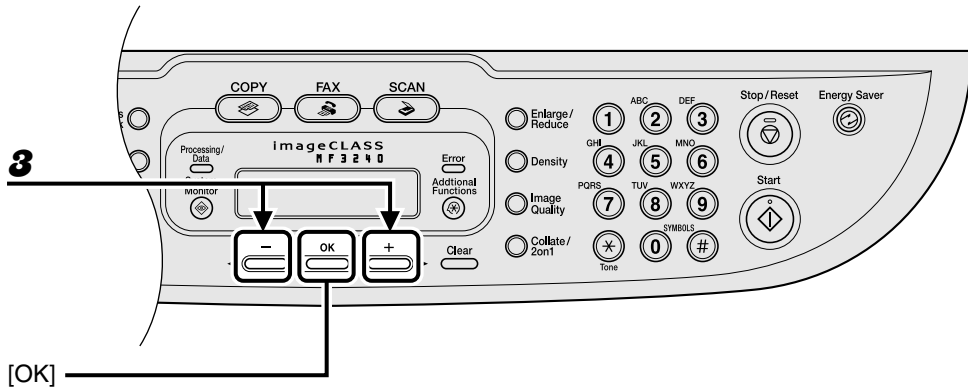

3 Press [**←**] or [**→**] to select the resolution, then press [**OK**].

- <STANDARD> for most text-only documents. (200 × 100 dpi)
- <FINE> for fine-print documents (the resolution is twice that of <STANDARD>). (200 × 200 dpi)
- <PHOTO> for documents that contain photographs (the resolution is twice that of <STANDARD>). (200 × 200 dpi)
- <SUPER FINE> for documents that contain fine print and images (the resolution is four times that of <STANDARD>). (200 × 400 dpi)

Density

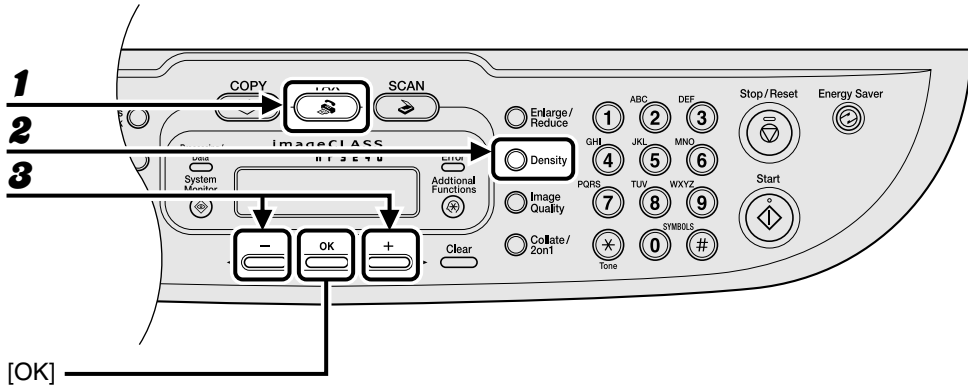

1 Press [FAX].

2 Press [Density].

Ex.

```
D E N S I T Y
- L T      █ █ █ █ █      D K +
```

3 Press [←] or [→] to adjust the density, then press [OK].

[→]: to make light documents darker

[←]: to make dark documents lighter

Speed Dialing

Speed dialing allows you to dial fax/telephone numbers by simply pressing one or a few keys. The following speed dialing methods are available:

- **One-Touch Speed Dialing (p. 4-7)**
 - Register a fax/telephone number for one-touch speed dialing, then to dial the number, simply press the one-touch speed dialing key assigned to that number. You can register up to 7 one-touch speed dialing keys, including group dialing.
- **Coded Dialing (p. 4-14)**
 - Register a fax/telephone number for coded dialing, then to dial the number, simply press [Coded Dial] and enter the two-digit code assigned to that number. You can register up to 100 coded dialing codes.
- **Group Dialing (p. 4-21)**
 - Register a group of fax numbers (must be registered for one-touch speed dialing and/or coded dialing) for group dialing, then to send a document to all numbers in that group, simply press the one-touch speed dialing key assigned to that group. You can register up to 50 destinations into a one-touch speed dialing key as a group.

Registering Recipients for Speed Dialing

For each recipient, you can register:

- Name
- Fax number (required)

● Registering One-Touch Speed Dialing

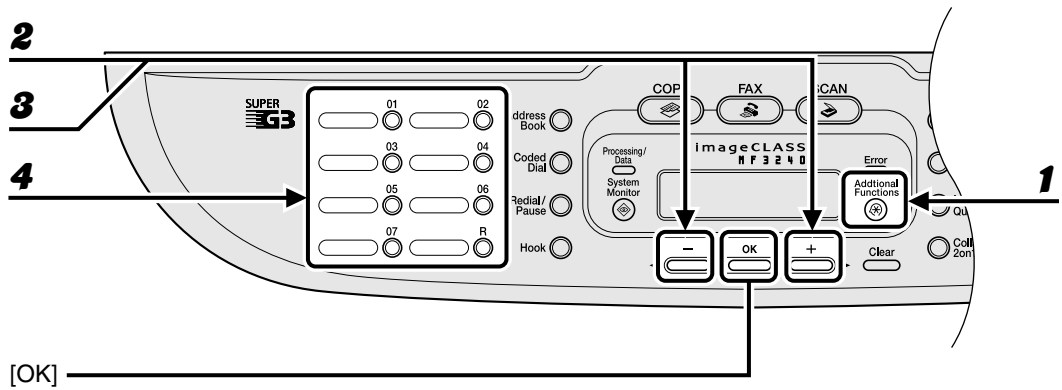

1 Press [Additional Functions].

2 Press [◀] or [▶] to select <ADDRESS BOOK SET.>, then press [OK].

3 Press [◀] or [▶] to select <1-TOUCH SPD DIAL>, then press [OK].

4 Press a one-touch speed dialing key (01 to 07) for a registering fax number, then press [OK].

You can also select a one-touch speed dialing number with [◀] or [▶].

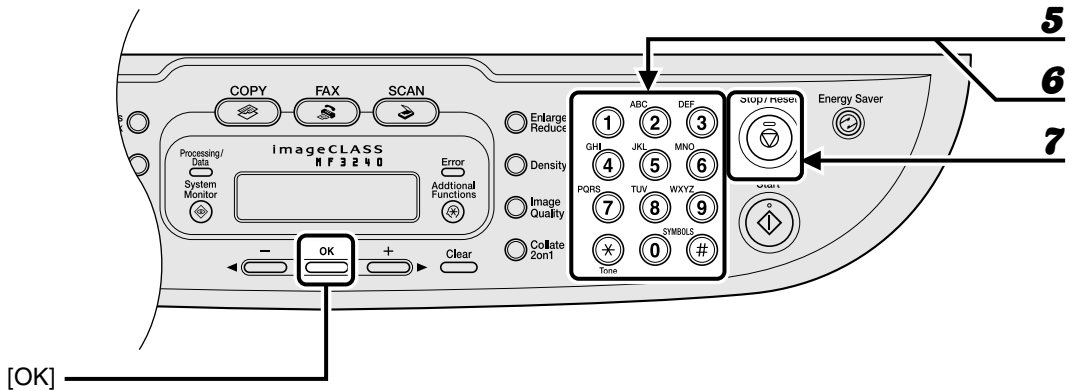

- 5** Enter the destination name (max. 20 characters, including spaces) with the numeric keys, then press [OK].

Ex.

NAME [A] CAN

- 6** Enter the fax number you register (max. 50 digits, including spaces and pauses) with the numeric keys, then press [OK].

Ex.

TEL NUMBER ENTRY 0 1 2 X X X X X X X X _

If you register another one-touch speed dialing key, repeat the procedure from step 4.

- 7** Press [Stop/Reset] to return to standby mode.

● Editing One-Touch Speed Dialing

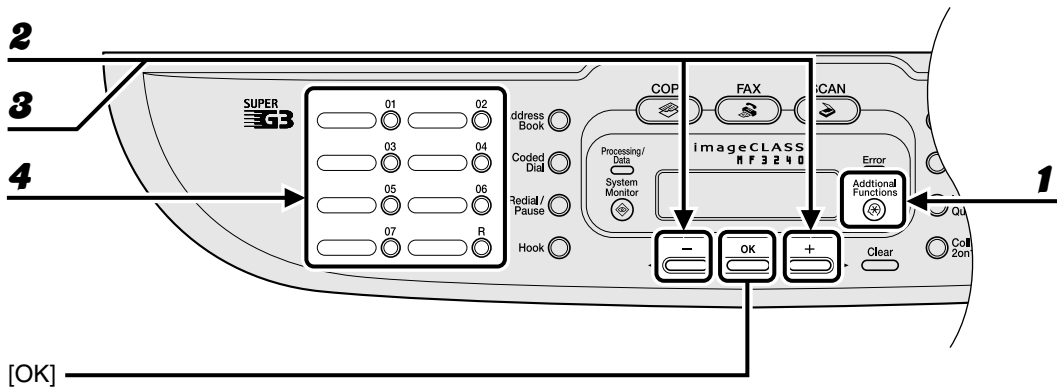

- 1** Press [Additional Functions].
- 2** Press [◀] or [▶] to select <ADDRESS BOOK SET.>, then press [OK].
- 3** Press [◀] or [▶] to select <1-TOUCH SPD DIAL>, then press [OK].
- 4** Press the one-touch speed dialing key (01 to 07) you want to edit, then press [OK].

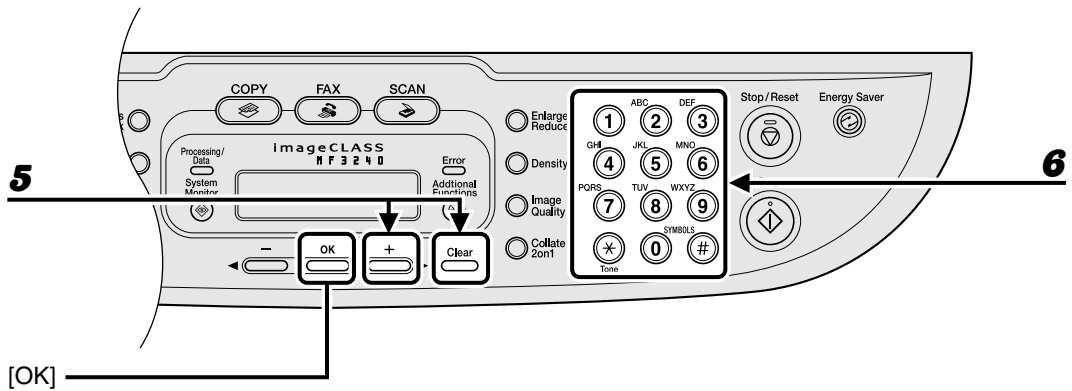

- 5** Press [+ ▶] repeatedly to go to the wrong character, then press [Clear] to delete it.
To delete the entire name, press and hold [Clear].
- 6** Enter a new character with the numeric keys, then press [OK].

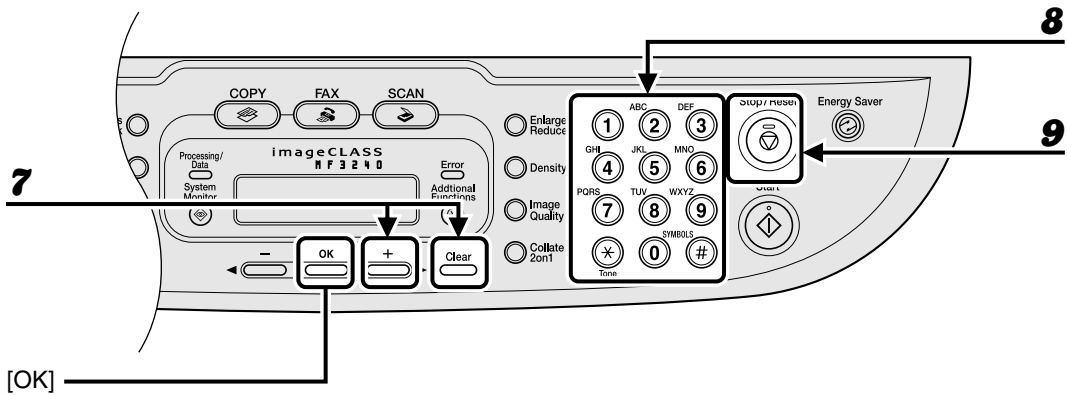

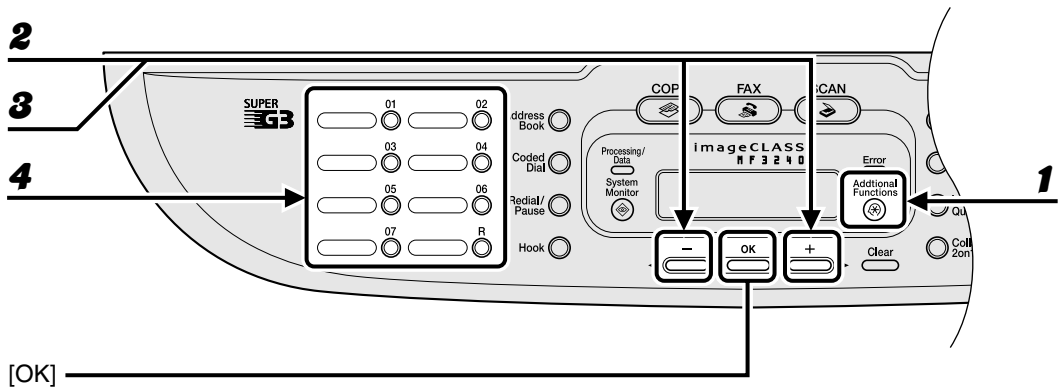

- 7** Press [+ ▶] repeatedly to go to the wrong number, then press [Clear] to delete it.
To delete all numbers, press and hold [Clear].
- 8** Enter a new number with the numeric keys, then press [OK].
- 9** Press [Stop/Reset] to return to standby mode.

● Deleting One-Touch Speed Dialing

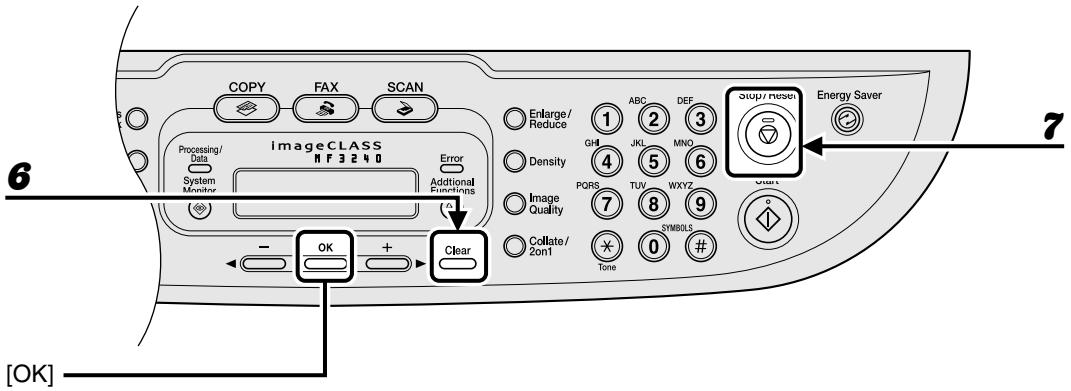

- 1** Press [Additional Functions].
- 2** Press [◀] or [▶] to select <ADDRESS BOOK SET.>, then press [OK].
- 3** Press [◀] or [▶] to select <1-TOUCH SPD DIAL>, then press [OK].
- 4** Press the one-touch speed dialing key (01 to 07) you want to delete, then press [OK].



- 5** Press [OK].
 - 6** Press and hold [Clear] to delete all numbers, then press [OK].
-  **NOTE**
When deleting all numbers, the registered name is cleared automatically.
- 7** Press [Stop/Reset] to return to standby mode.

● Registering Coded Dialing

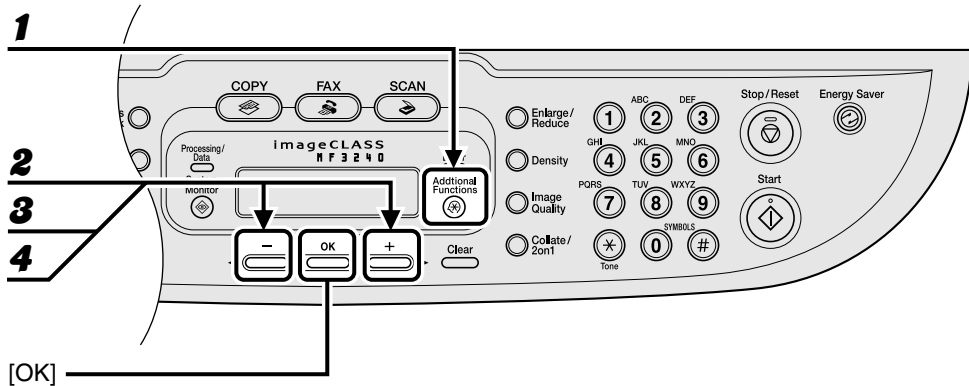

- 1** Press [Additional Functions].
- 2** Press [◀] or [▶] to select <ADDRESS BOOK SET.>, then press [OK].
- 3** Press [◀] or [▶] to select <CODED DIAL>, then press [OK].
- 4** Press [◀] or [▶] to select a coded dialing code (00 to 99), then press [OK].

You can also enter a coded dialing code with the numeric keys after pressing [Coded Dial].

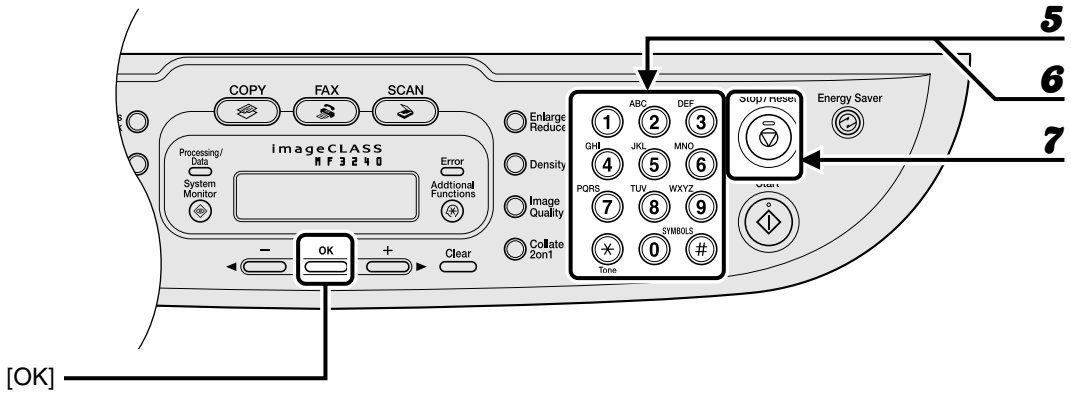

5 Enter the destination name (max. 20 characters, including spaces) with the numeric keys, then press [OK].

Ex.

NAME	[A]
CAN	

6 Enter the fax number you register (max. 50 digits, including spaces and pauses) with the numeric keys, then press [OK].

Ex.

TEL NUMBER ENTRY
0 1 2 X X X X X X X X _

If you register another coded dialing number, repeat the procedure from step 4.

7 Press [Stop/Reset] to return to standby mode.

● Editing Coded Dialing

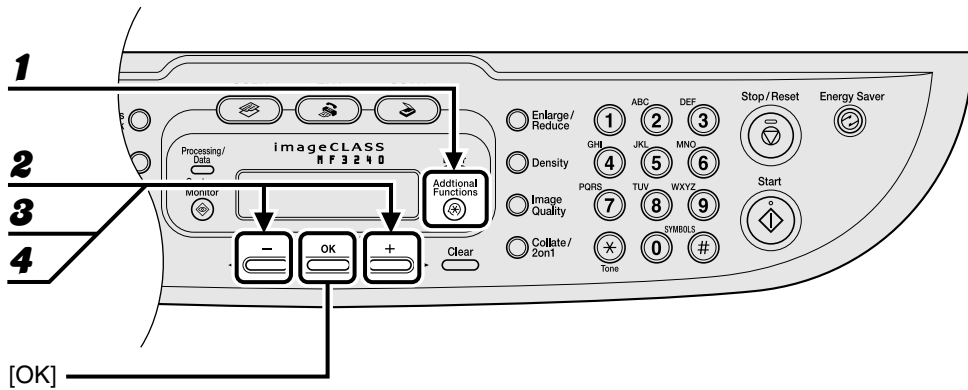

- 1** Press [Additional Functions].
- 2** Press [◀] or [▶] to select <ADDRESS BOOK SET.>, then press [OK].
- 3** Press [◀] or [▶] to select <CODED DIAL>, then press [OK].
- 4** Press [◀] or [▶] to select the coded dialing code (00 to 99) that you want to edit, then press [OK].

You can also enter a coded dialing code with the numeric keys after pressing [Coded Dial].

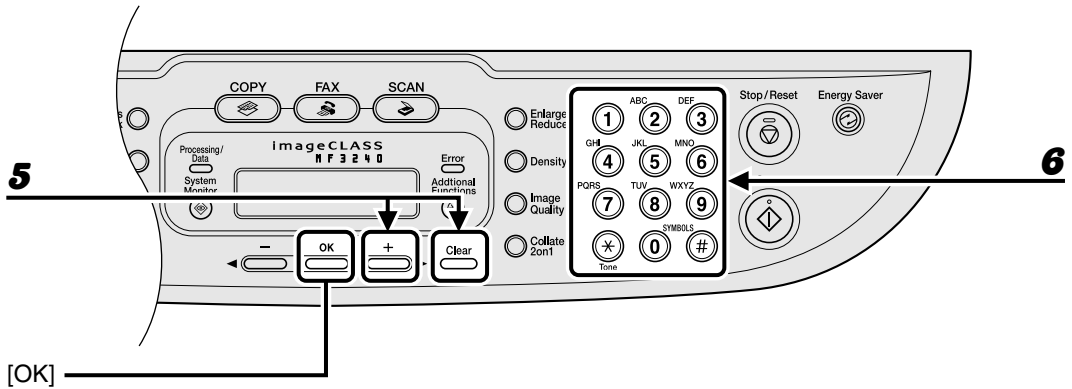

5 Press [+ ▶] repeatedly to go to the wrong character, then press [Clear] to delete it.

To delete the entire name, press and hold [Clear].

6 Enter a new character with the numeric keys, then press [OK].

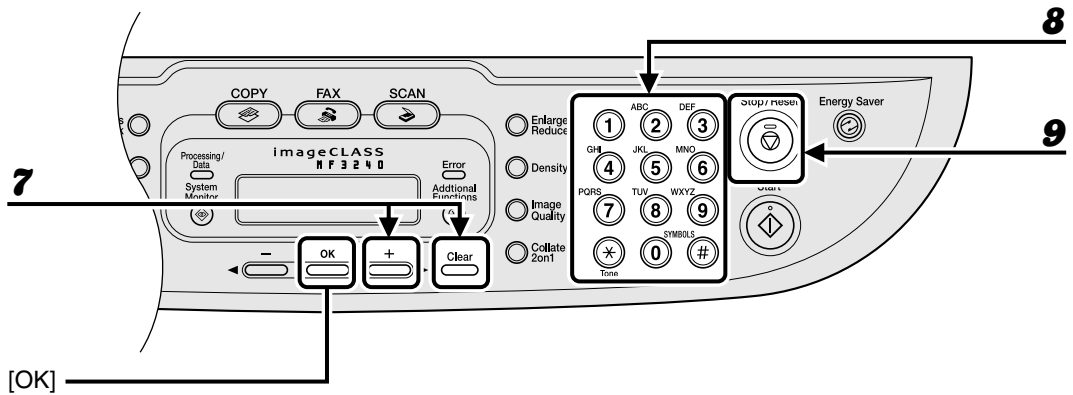

- 7** Press [**+ ▶**] repeatedly to go to the wrong number, then press [**Clear**] to delete it.
To delete all numbers, press and hold [**Clear**].
- 8** Enter a new number with the numeric keys, then press [**OK**].
- 9** Press [**Stop/Reset**] to return to standby mode.

● Deleting Coded Dialing

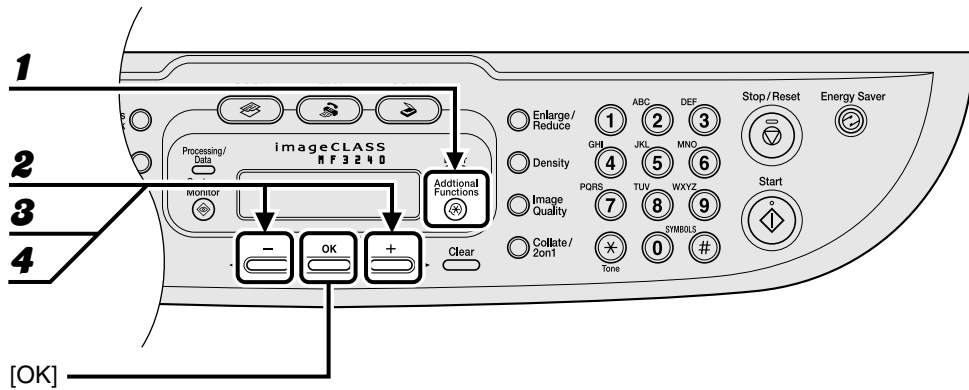

- 1** Press [Additional Functions].
- 2** Press [←] or [→] to select <ADDRESS BOOK SET.>, then press [OK].
- 3** Press [←] or [→] to select <CODED DIAL>, then press [OK].
- 4** Press [←] or [→] to select the coded dialing code (00 to 99) that you want to delete, then press [OK].

You can also enter a coded dialing code with the numeric keys after pressing [Coded Dial].

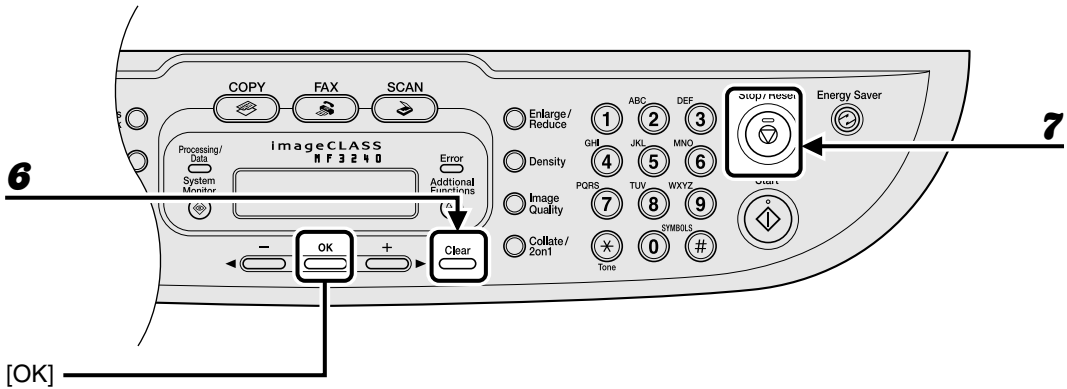

- 5** Press [OK].
 - 6** Press and hold [Clear] to delete all numbers, then press [OK].
-  **NOTE**
When deleting all numbers, the registered name is cleared automatically.
- 7** Press [Stop/Reset] to return to standby mode.

● Registering Group Dialing

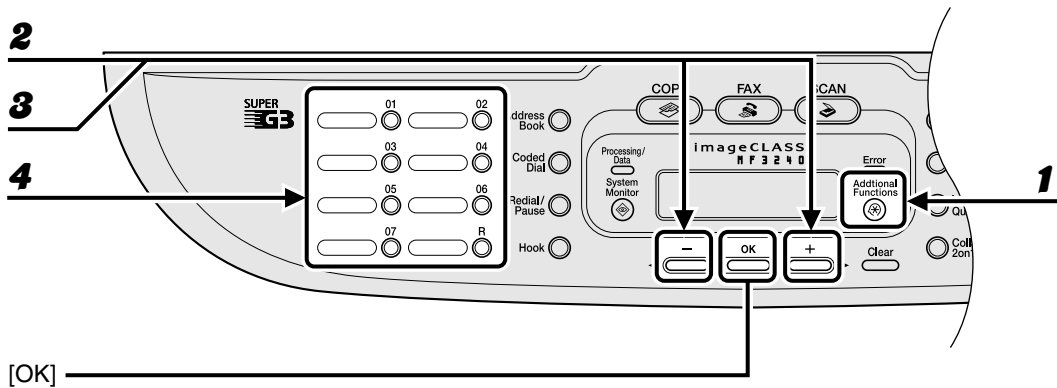

[OK]

- 1** Press [Additional Functions].
- 2** Press [◀] or [▶] to select <ADDRESS BOOK SET.>, then press [OK].
- 3** Press [◀] or [▶] to select <GROUP DIAL>, then press [OK].
- 4** Specify an empty one-touch speed dialing key that you want to set as the group dial, then press [OK].

For details on selecting a one-touch speed dialing key, see “Registering One-Touch Speed Dialing,” on p. 4-7.

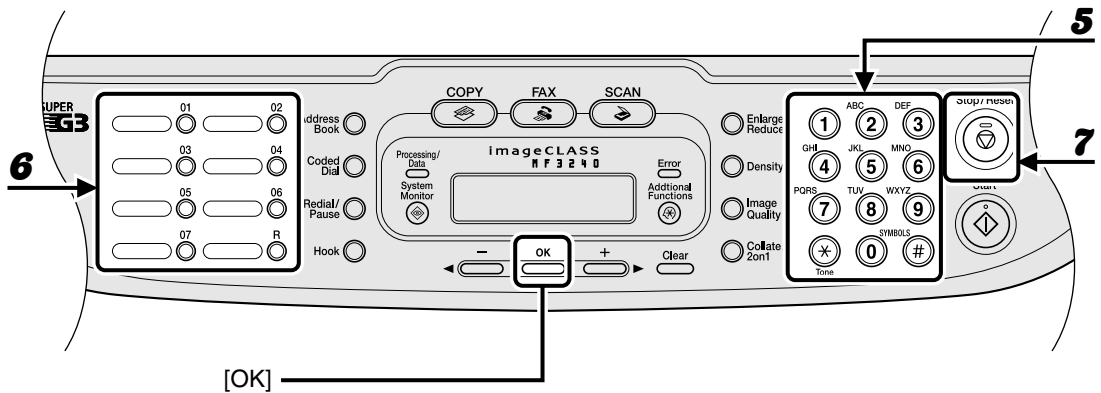

- 5** Enter the group name (max. 20 characters, including spaces) with the numeric keys, then press [OK].

Ex.

NAME	[A]
CANON GROUP	

- 6** Select the speed dialing numbers you want to register in the group (max. 50 destinations) until all destinations are registered, then press [OK].

The speed dialing number refers to the one-touch dialing number or coded dialing code under which the fax/telephone number is registered.

To enter a number stored under a one-touch speed dialing key, press the desired one-touch speed dialing key(s).

To enter a number stored under a coded dialing code, press [Coded Dial], then enter the two-digit code for the number with the numeric keys. For multiple entries, press [Coded Dial] between each entry.

NOTE

You can review the destinations which has been already entered with [◀-] or [+▶].

- 7** Press [Stop/Reset] to return to standby mode.

● Adding New Destination to Group

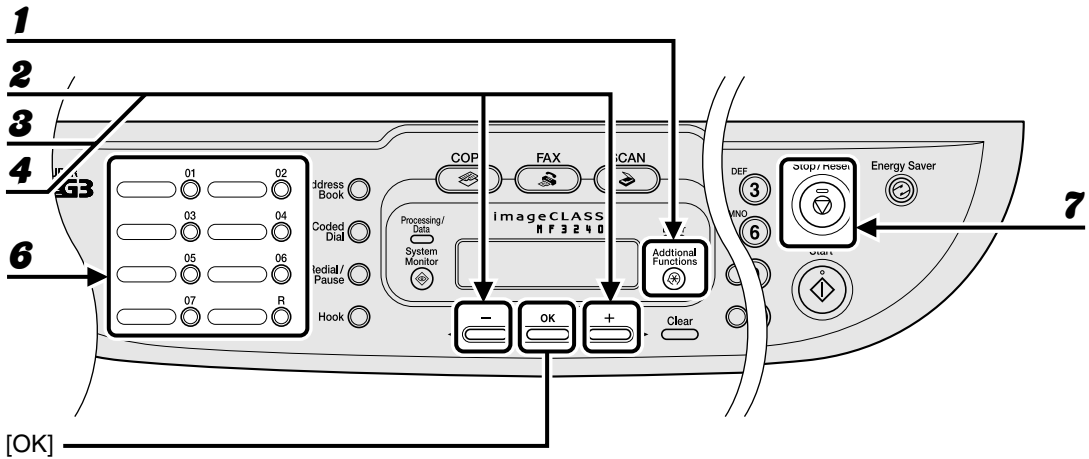

- 1** Press [Additional Functions].
- 2** Press [◀] or [▶] to select <ADDRESS BOOK SET.>, then press [OK].
- 3** Press [◀] or [▶] to select <GROUP DIAL>, then press [OK].
- 4** Press [◀] or [▶] to select a group dial to edit, then press [OK].
The group name appears.
- 5** Press [OK].
- 6** Select the speed dialing number you want to add to the group, then press [OK].
For details on entering the speed dialing number, see “Registering Group Dialing,” on p. 4-21.
- 7** Press [Stop/Reset] to return to standby mode.

● Deleting Destination from Group

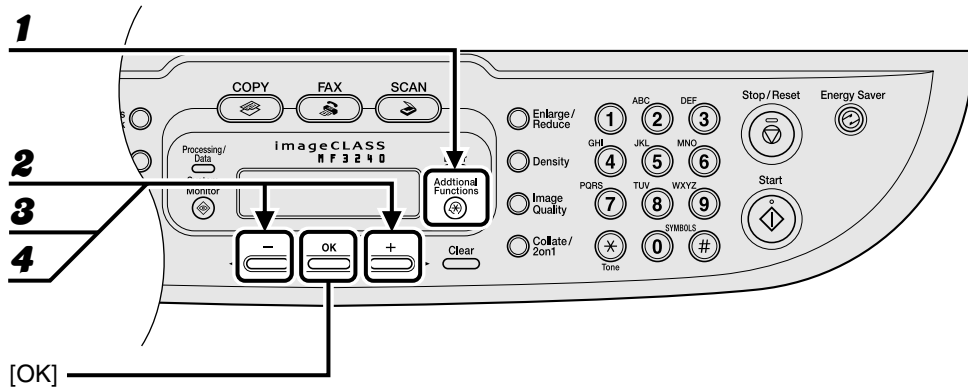

- 1** Press [Additional Functions].
- 2** Press [◀] or [▶] to select <ADDRESS BOOK SET.>, then press [OK].
- 3** Press [◀] or [▶] to select <GROUP DIAL>, then press [OK].
- 4** Press [◀] or [▶] to select a group dial to delete, then press [OK].
The group name appears.
- 5** Press [OK].



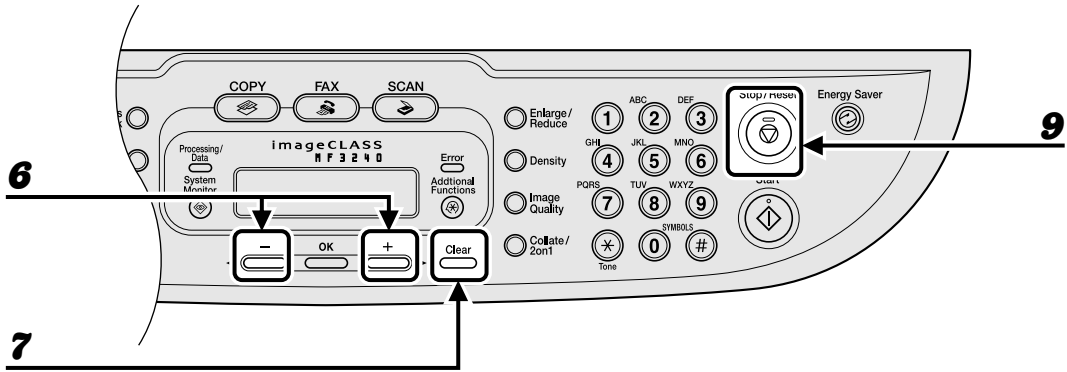

- 6** Press [**←**] or [**→**] to display the speed dial number you want to delete from the group.
- 7** Press [**Clear**].
- 8** Repeat steps 6 and 7 if you want to delete another speed dialing number, then press [**OK**].
- 9** Press [**Stop/Reset**] to return to standby mode.

● Changing Group Name

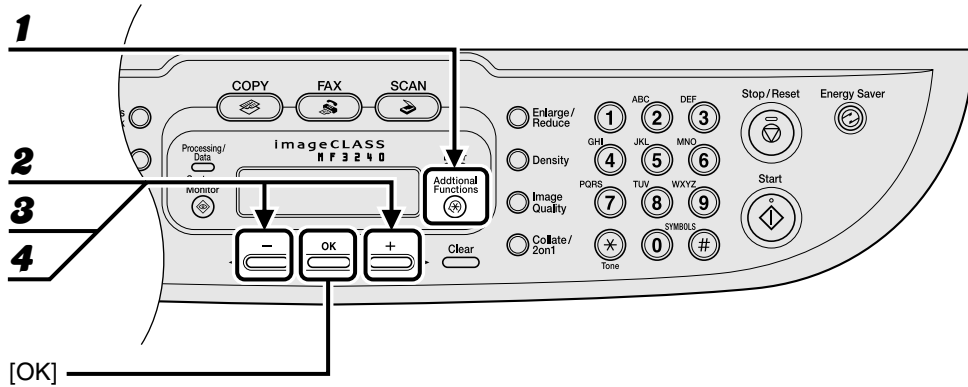

- 1** Press [Additional Functions].
- 2** Press [◀] or [▶] to select <ADDRESS BOOK SET.>, then press [OK].
- 3** Press [◀] or [▶] to select <GROUP DIAL>, then press [OK].
- 4** Press [◀] or [▶] to select a group dial to edit, then press [OK].



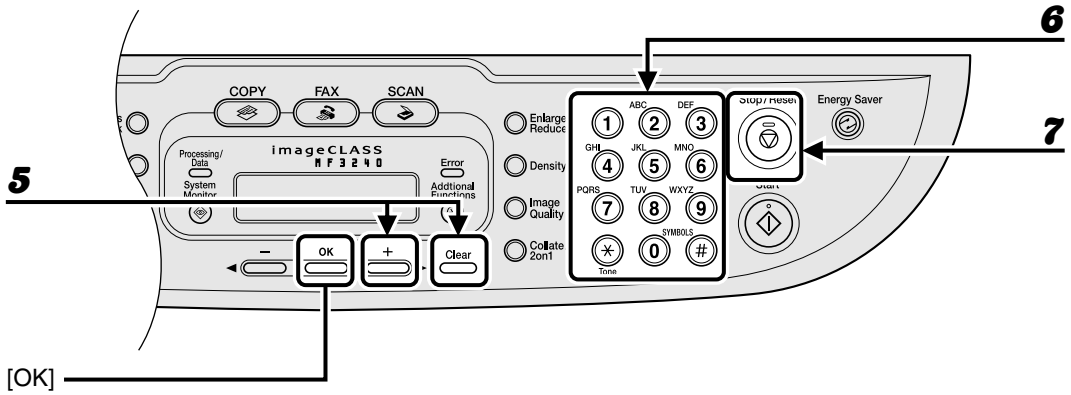

- 5** Press [+ ▶] repeatedly to go to the wrong character, then press [Clear] to delete it.
To delete the entire character, press and hold [Clear].
- 6** Enter a new name with the numeric keys, then press [OK].
- 7** Press [Stop/Reset] to return to standby mode.

● Deleting Group Dialing

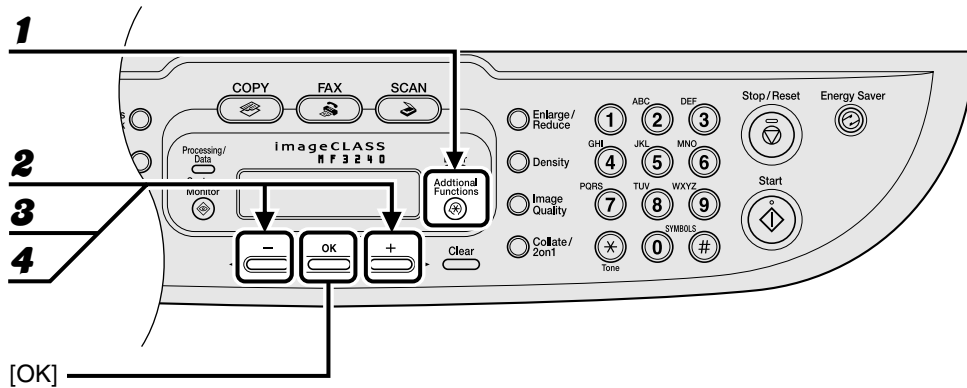

- 1** Press [Additional Functions].
- 2** Press [◀] or [▶] to select <ADDRESS BOOK SET.>, then press [OK].
- 3** Press [◀] or [▶] to select <GROUP DIAL>, then press [OK].
- 4** Press [◀] or [▶] to select a group dial to delete, then press [OK].
The group name appears.
- 5** Press [OK].



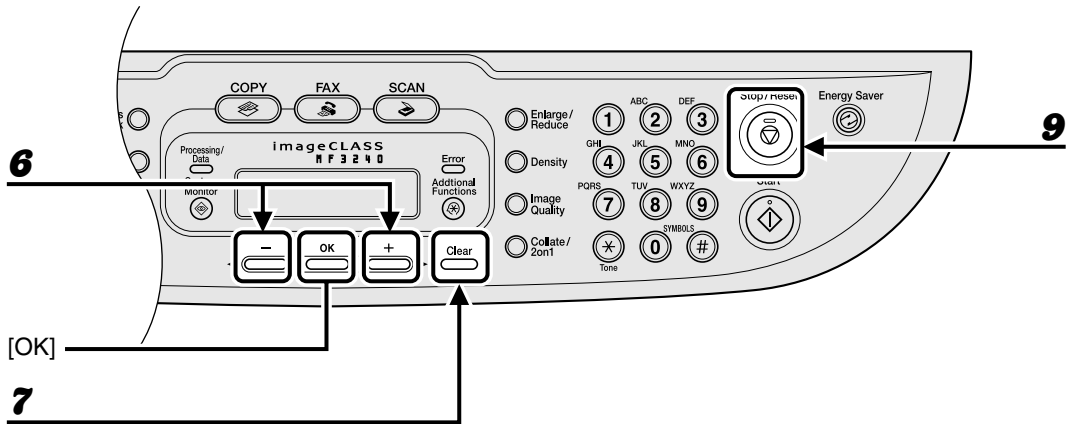

- 6** Press [**←**] or [**→**] to display a speed dial number.
 - 7** Press [**Clear**].
 - 8** Repeat steps 6 and 7 until all speed dial numbers are deleted, then press [**OK**].
-  **NOTE**
When deleting all speed dial numbers, the group name is cleared automatically.
- 9** Press [**Stop/Reset**] to return to standby mode.

Using Speed Dialing

Follow the procedure below to send faxes to registered recipients using speed dialing. For easy reference, print out the list of recipients registered for speed dialing. (See Chapter 4, “Reports and Lists (MF3240 Only),” in the Advanced Guide.)

● Using One-Touch Speed/Group Dialing

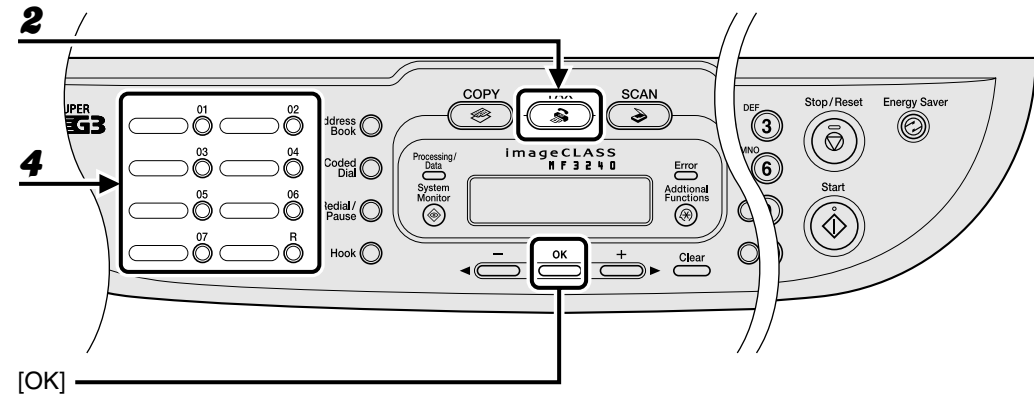

- 1** Place the document on the platen glass.
- 2** Press [FAX].
- 3** Adjust any necessary settings for your document.
For details, see “Scan Settings,” on p. 4-3.
- 4** Press the desired one-touch speed or group dialing key (01 to 07).
If you want to scan multiple pages, set the documents one by one, then press [Start].
- 5** Press [OK] to start dialing.

● Using Coded Dialing

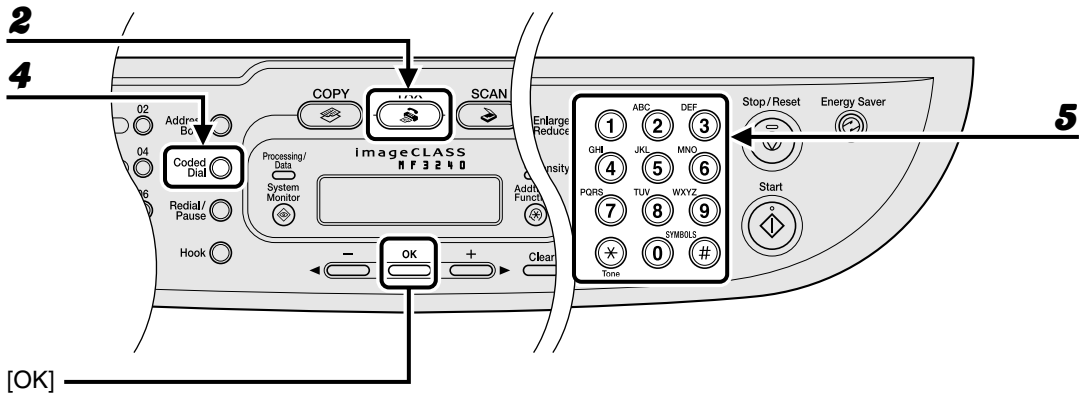

- 1** Place the document on the platen glass.
- 2** Press [FAX].
- 3** Adjust any necessary settings for your document.
For details, see “Scan Settings,” on p. 4-3.
- 4** Press [Coded Dial].
- 5** Enter the desired two-digit code (00 to 99) with the numeric keys.

Ex.

= 0 1 2 X X X X X X X
[* 0 1] CANON

If you want to scan multiple pages, set the documents one by one, then press [Start].

- 6** Press [OK] to start dialing.

5

Receiving Faxes

(MF3240 Only)

Follow this procedure to set the machine for receiving faxes.

For advanced receiving features, see Chapter 1, “Advanced Fax Features (MF3240 Only),” in the Advanced Guide.

1 Enter the Setting Menu

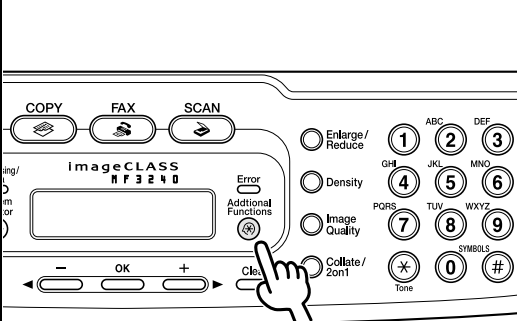

The diagram shows the control panel of the MF3240. At the top are three buttons: COPY, FAX, and SCAN. Below them is a display area with 'ImageCLASS MF3240' and an 'Error' indicator. To the right of the display are several function buttons: Enlarge/Reduce, Density, Image Quality, and Additional Functions. A hand is shown pointing to the 'Additional Functions' button. Below the display are navigation buttons: a left arrow, OK, a right arrow, and a 'Clear' button. To the right of these are more function buttons: Collate/Zon1, a tone button, and a '#' button. A numeric keypad with letters is also visible.

Press [Additional Functions].

2 Enter the Receive Mode

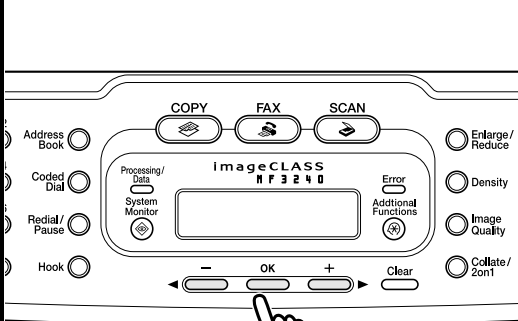

The diagram shows the control panel of the MF3240. At the top are three buttons: COPY, FAX, and SCAN. Below them is a display area with 'ImageCLASS MF3240' and an 'Error' indicator. To the left of the display are several function buttons: Address Book, Coded Dial, Redial/Pause, and Hook. To the right of the display are several function buttons: Enlarge/Reduce, Density, Image Quality, and Collate/Zon1. A hand is shown pointing to the 'OK' button. Below the display are navigation buttons: a left arrow, OK, a right arrow, and a 'Clear' button.

Select <FAX SETTINGS> with [◀] or [▶], then press [OK].

Select <RX SETTINGS> with [◀] or [▶], then press [OK].

Select <RX MODE> with [◀] or [▶], then press [OK].

3 Select the Receive Mode

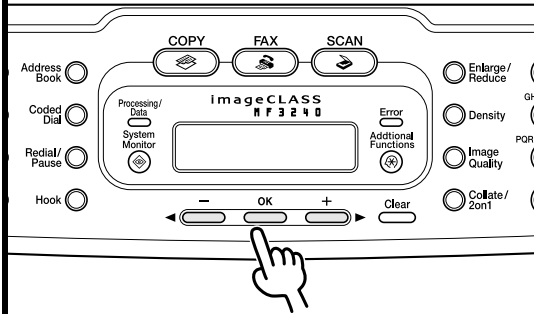

Select receive mode with [**←**] or [**→**], then press [**OK**].

- <FaxOnly>: Answers all calls as faxes.
- <AnsMode>: Receives faxes automatically and records voice messages.
- <NET SWITCH>: Distinguishes between fax and voice calls.
- <FaxTel>: Switches between fax and voice calls automatically.
- <MANUAL>: Does not answer any calls. You have to manually receive faxes.

NOTE

- For <AnsMode>, make sure an answering machine is connected to the machine.
- The <NET SWITCH> mode is available for certain countries only and requires subscription to a network switch service.

4 Exit the Setting Menu

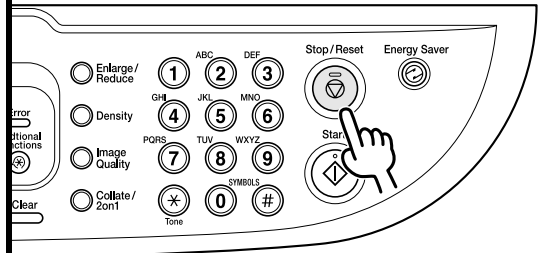

Press [**Stop/Reset**] to return to standby display.

What if...

● You press [**Stop/Reset**] to cancel a job:

The <CANCEL DURING TX/RX?> message appears. Press [**←**] to select <Yes>. The job is canceled, and the display returns to standby mode.

● The <OUT OF TONER/CHANGE TONER> message appears:

The toner cartridge is almost empty. Replace the toner cartridge. For details on this error message, see “LCD Messages,” on p. 11-7.

6 Copying

Follow this procedure to make a copy.

For advanced copying features, see Chapter 2, “Advanced Copy Features,” in the Advanced Guide.

1 Set a Document

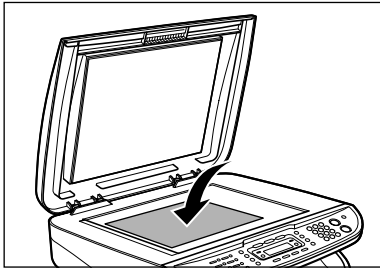

Place the document on the platen glass.

For documents you can copy, see “Document Requirements,” on p. 2-1.

2 Enter the Copy Mode

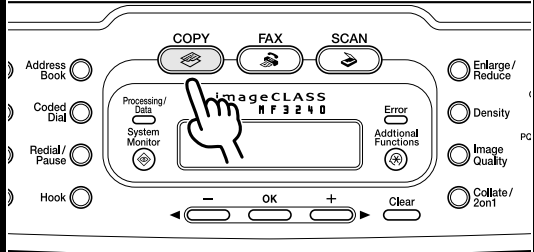

Press [COPY].

The COPY indicator lights and the machine enters copy standby mode.

What if...

- **You want to adjust the resolution and density:**
See “Scan Settings,” on p. 6-3.

3 Enter the Copy Quantity

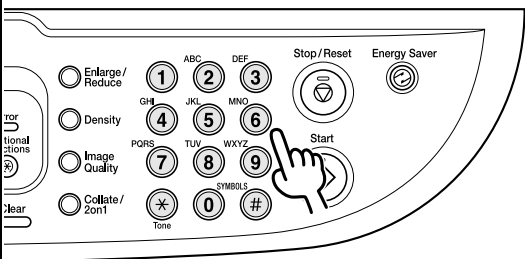

Enter the copy quantity (1 to 99) with the numeric key.

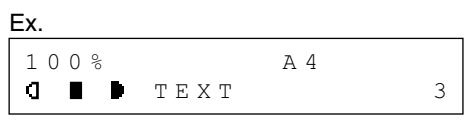

What if...

- You enter a wrong number: Press [Clear] and enter a new number.

4 Start Copying

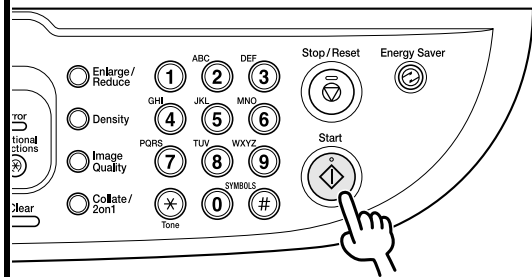

Press [Start].

What if...

- You press [Stop/Reset] to cancel a job while scanning documents: The job is canceled immediately, and the copy quantity is reset.
- You press [Stop/Reset] to cancel a job while printing: The <CANCEL COPYING?> message appears. Press [←] to select <YES>.

Scan Settings

Before pressing [Start] to begin copying, you can adjust scan settings to better suit the document to be scanned. These settings return to the default values if Auto Clear function is activated or if you press [Stop/Reset].

Image Quality

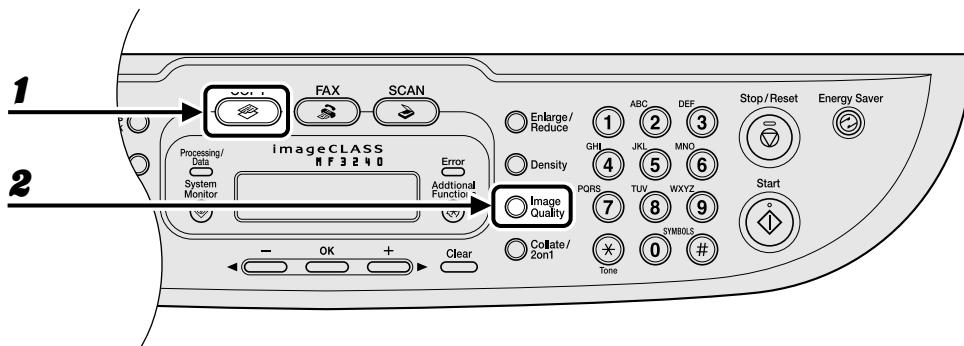

1 Press [COPY].

2 Press [Image Quality] repeatedly to select the document type.

<TEXT>: For text documents.

<PHOTO>: For documents that contain fine text or photos.

<TEXT/PHOTO>: For documents that contain text and photos.

 **NOTE**

Copy density automatically changes to manual mode when <TEXT/PHOTO> or <PHOTO> is set.

Density

You can adjust the density to the most appropriate level for the document either automatically or manually.

● Adjusting Automatically

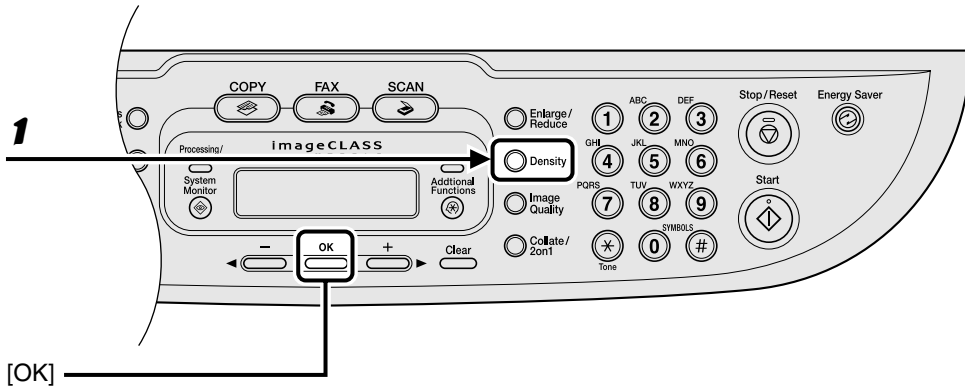

1 Press [Density] until <AUTO> appears, then press [OK].

NOTE

The image quality is automatically set to <TEXT>.

● Adjusting Manually

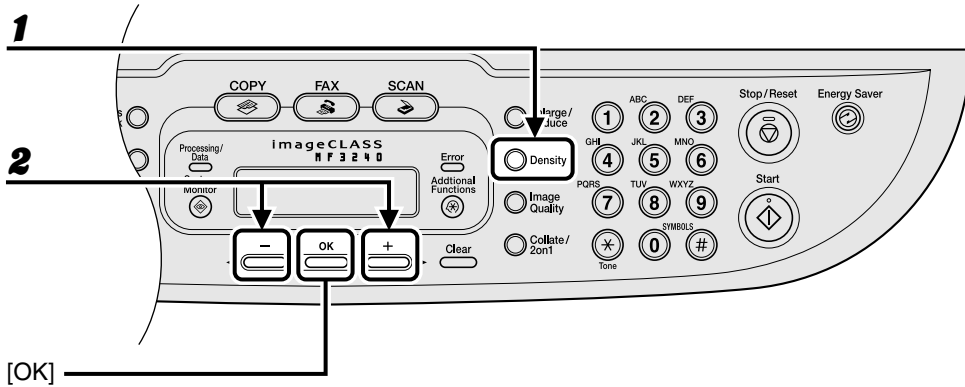

1 Press [Density] until the manual mode appears.

Ex.



2 Press [←] or [→] to adjust the copy density, then press [OK].

[→]: to make light documents darker

[←]: to make dark documents lighter

Zoom Ratio

● Preset Zoom

You can enlarge or reduce documents from one standard paper size to another.

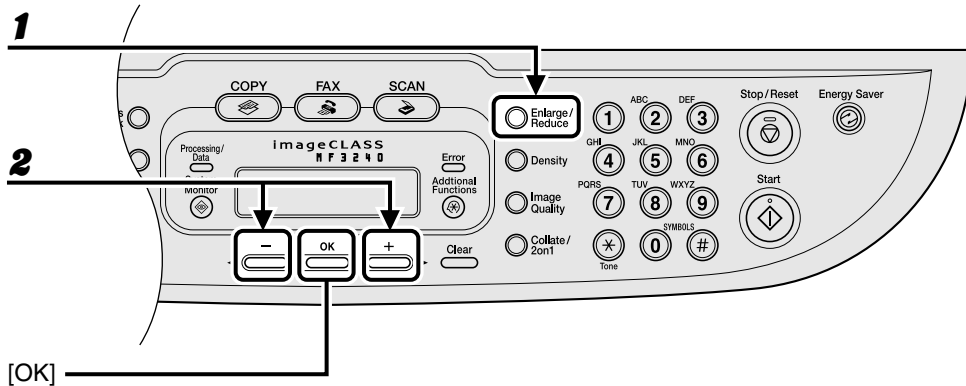

1 Press [Enlarge/Reduce].

2 Press [←] or [→] to select the copy ratio, then press [OK].

- 200% MAX.
- 141% A5 → A4
- 122% A5 → B5
- 115% B5 → A4
- 100%
- 86% A4 → B5
- 81% B5 → A5
- 70% A4 → A5
- 50% MIN.

NOTE

When <PAPER SIZE GROUP> in the <COPY SETTINGS> menu is set to <INCHES> or <A>, the preset copy ratios change as follows:

INCHES: 50%, 64%, 78%, 100%, 129%, 200%

A: 50%, 70%, 100%, 141%, 200%

● Zoom Designation

You can reduce or enlarge images by any copy ratio, in 1 % increments. The available copy ratios are from 50 % to 200 %.

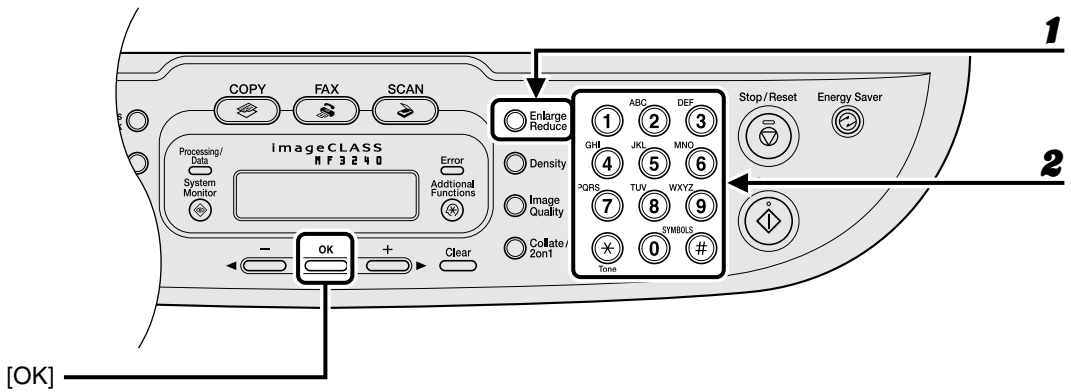

- 1** Press [Enlarge/Reduce] twice.
- 2** Enter the copy ratio with the numeric keys, then press [OK].

Ex.

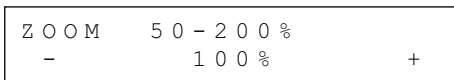

You can use [◀-] or [+▶] to adjust the zoom ratio. To increase the zoom ratio, press [+▶]. To decrease the copy ratio, press [◀-].

NOTE

To return the copy ratio to 100%, press [Stop/Reset].

7

Printing

Follow this procedure to print a document from your computer.

Make sure that the printer driver is installed.

For details on printing features, see Chapter 2, “Printing,” in the Software Guide.

1 Start the Print Command

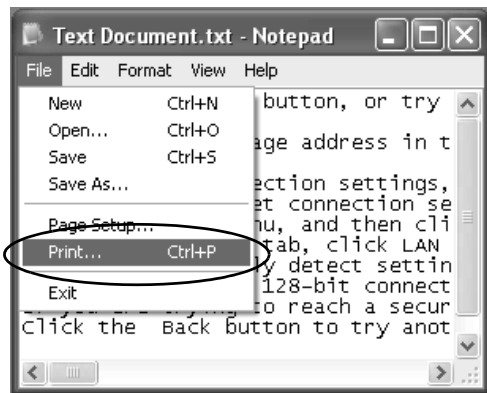

From an open document on an application, click [File] > [Print].

2 Select the Printer

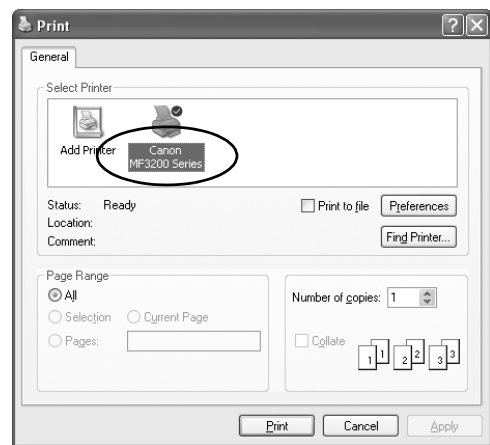

Select the printer icon for the machine ([Canon MF3200 Series]).

3 Adjust Preferences

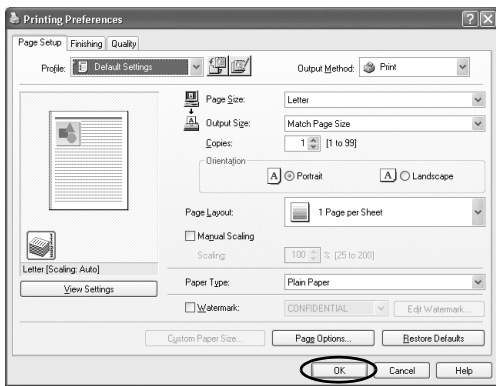

Click [Preferences] or [Properties] to open the dialog box. After finished, click [OK].

4 Print the Document

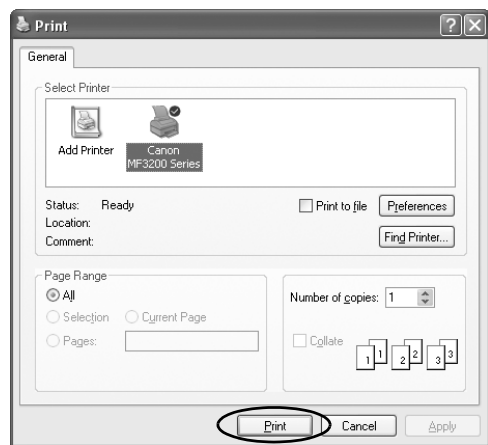

Click [Print] or [OK].

What if...

- **You want to cancel printing:**
See Chapter 3, “System Monitor,” in the Advanced Guide.

8 Scanning

Follow this procedure to scan a document to your computer.

Make sure that the scanner driver is installed.

For details on scanning features, see Chapter 3, "Scanning a Document," in the Software Guide.

1 Set a Document

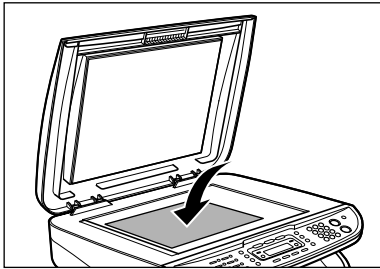

Place the document on the platen glass.

For documents you can scan, see "Document Requirements," on p. 2-1.

2 Enter the Scan Mode

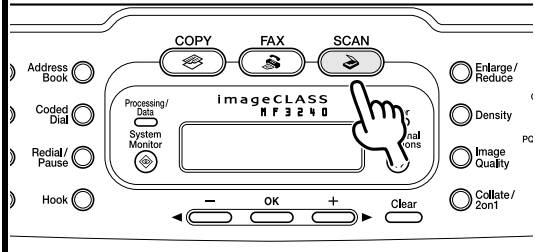

Press [SCAN].

The SCAN indicator lights up and the machine enters scan standby mode.

3 Start Scanning

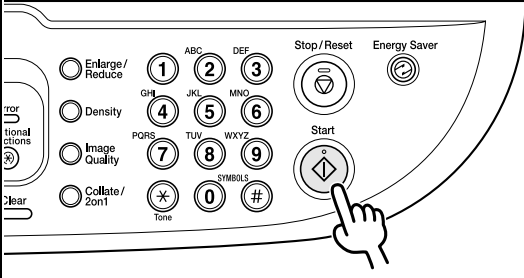

The diagram shows the control panel of a scanner. It features a numeric keypad (0-9) with letters above each number, a 'Start' button with a right-pointing arrow, a 'Stop/Reset' button with a square and a diagonal line, and an 'Energy Saver' button with a power symbol. Other buttons include 'Enlarge/Reduce', 'Density', 'Image Quality', 'Collate/Zoom', 'Tone', and 'Symbols'. A hand is shown pointing to the 'Start' button.

Press [Start].

The scanned data is transmitted to your computer and processed by the scan application. For more information on the scan application settings, see Chapter 3, “Scanning a Document,” in the Software Guide.

What if...

- **You want to cancel scanning:**
Press [Stop/Reset] on the operation panel, then click [OK] on the computer screen.

9 PC Faxing (MF3240 Only)

Follow this procedure to send a fax from your computer.

Make sure that the fax driver is installed.

For details on PC Faxing features, see Chapter 4, “PC Faxing (MF3240 Only),” in the Software Guide.

1 Start the Print Command

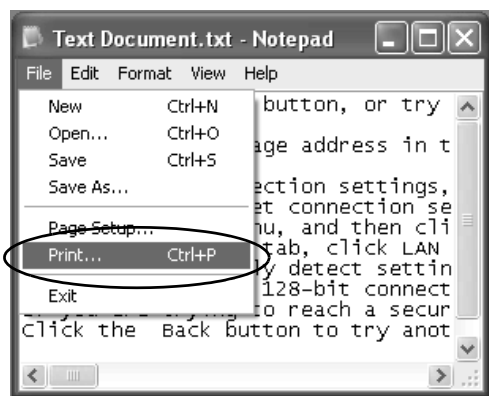

From an open document on an application, click [File] > [Print].

2 Select the Fax

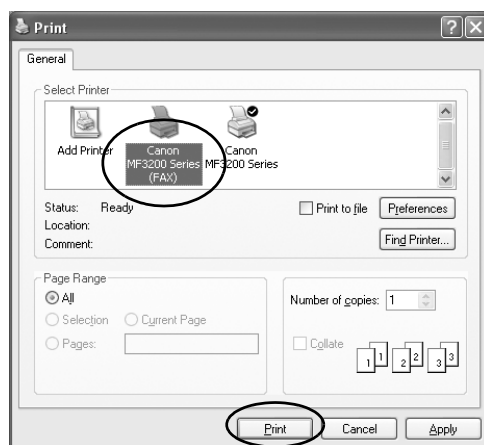

Select the fax icon ([Canon MF3200 Series(FAX)]), then click [Print].

What if...

- You want to adjust the fax properties: Click [Preferences] or [Properties] and adjust the settings.

3 Set the Destination

Fax Sending Settings

Sending Settings | Edit Address Book | Cover Sheet

Recipient Name: CANON

Fax Number: 012345XXXX

Add to Address Book

Add to Recipient List

Recipient List:

Recipient Name	Fax Number
CANON	012345XXXX

Address Book...

Delete

Number of Recipients: 1

OK Cancel Help

Specify the name and fax number in [Sending Settings], then click [Add to Recipient List].

What if...

- You want to send a fax with the cover sheet:
Click [Cover Sheet] tab and set the format for the cover sheet attachment.

4 Send the Document

Fax Sending Settings

Sending Settings | Edit Address Book | Cover Sheet

Recipient Name: CANON

Fax Number: 012345XXXX

Add to Address Book

Add to Recipient List

Recipient List:

Recipient Name	Fax Number
CANON	012345XXXX

Address Book...

Delete

Number of Recipients: 1

OK Cancel Help

Click [OK] in the Fax Sending Settings.

What if...

- You want to cancel sending a fax:
See Chapter 3, "System Monitor," in the Advanced Guide.

10 Maintenance

Cleaning the Machine

Note the following before cleaning your machine:

- Make sure no document is stored in memory, then disconnect the power cord.
- Use a soft cloth to avoid scratching the components.
- Do not use tissue paper, paper towels, or similar materials for cleaning; they can stick to the components or generate static charges.

 **CAUTION**

Never use volatile liquids such as thinners, benzene, acetone, or any other chemical cleaner to clean the machine. These can damage the machine components.

Exterior

- 1** Disconnect the power cord.
- 2** Wipe the machine's exterior with a clean, soft, lint-free cloth dampened with water or diluted dishwashing detergent solution.
- 3** Wait for the machine to dry, then reconnect the power cord.

Interior

Clean the machine's print area periodically to prevent toner powder and paper dust from accumulating inside.

1 Disconnect the power cord.

2 Open the front cover.

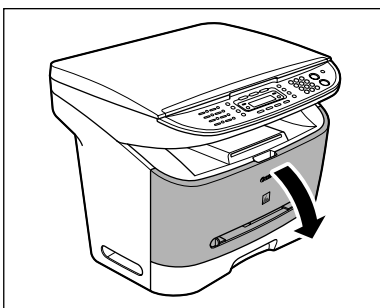

3 Remove the toner cartridge.

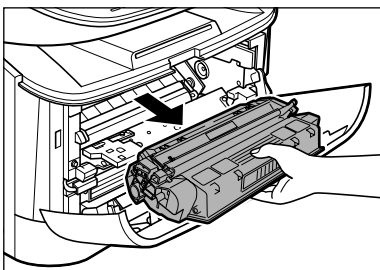

⚠ CAUTION

- To avoid exposing the toner cartridge to light, place it in its protective bag or wrap it in a thick cloth.
- Do not open the drum protective shutter on the toner cartridge. Print quality may deteriorate if the drum surface is exposed to light or is damaged.

4 Use a clean, soft, dry, lint-free cloth to remove any toner or paper debris from the machine's interior.

⚠ CAUTION

- Do not touch the fixing assembly (A) as it becomes very hot during use.
- Do not touch the transfer roller (B) as this can damage the machine.

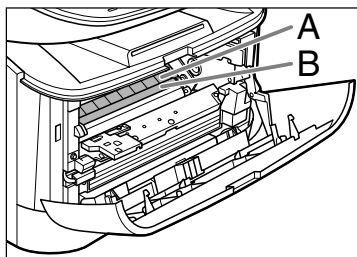

- If loose toner comes into contact with your skin or clothing, wash with cold water. Warm water will set the toner.



5 Insert the toner cartridge into the machine as far as it will go.

Hold the toner cartridge and align the protrusions (A) on both sides of the toner cartridge to the guides (B) in the machine, then gently slide the toner cartridge into the machine as far as it will go.

Be sure to position the arrow mark (C) on the toner cartridge towards the inside of the machine.

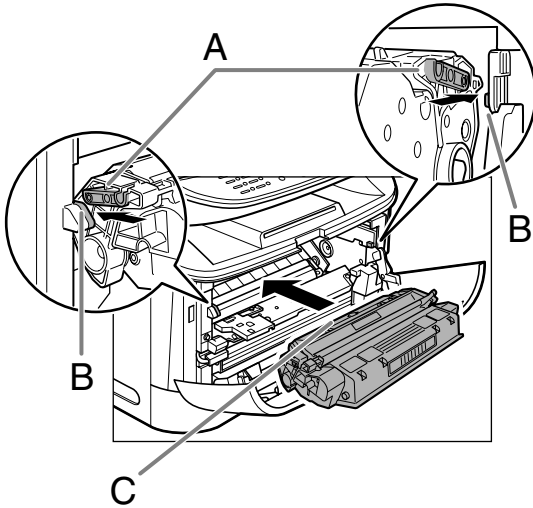

6 Close the front cover.

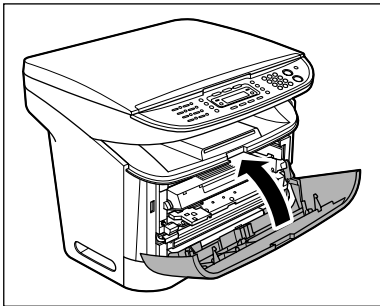

CAUTION

Be careful not to get your fingers caught.

7 Reconnect the power cord.

Scanning area

Keep the scanning area clean to avoid dirty copies or faxes to be sent.

- 1** Open the platen glass cover.

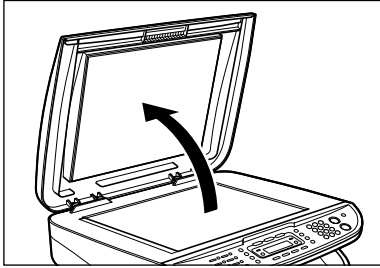

- 2** Clean the platen glass and the underside of the platen glass cover with a cloth dampened with water. Then, wipe the area with a soft, dry cloth.

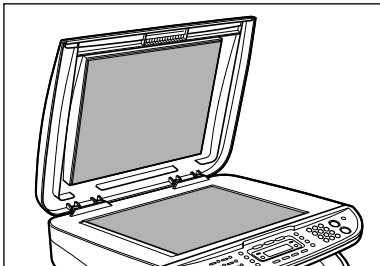

 **NOTE**

Do not dampen the cloth too much, as this may tear the document or damage the machine.

- 3** Close the platen glass cover.

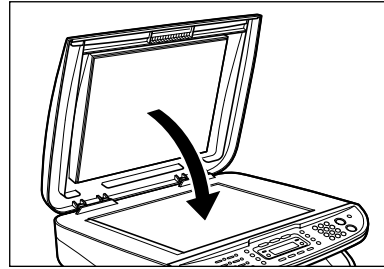

 **CAUTION**

Be careful not to get your fingers caught.

Replacing the Toner Cartridge

On MF3240, when the LCD displays <OUT OF TONER/CHANGE TONER>, redistribute toner in the toner cartridge. If the message persists, replace the toner cartridge.

On MF3222, when the printout has vertical white streaks, redistribute the toner inside the cartridge. If the problem persists, replace the cartridge.

- 3** Gently rock the toner cartridge five or six times to distribute toner evenly.

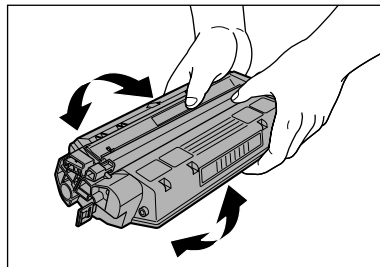

Redistributing Toner

- 1** Open the front cover.

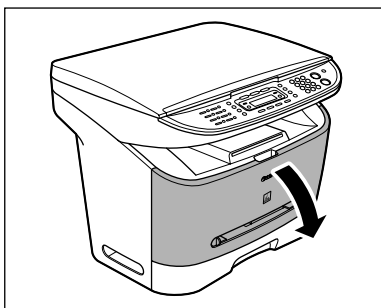

- 2** Remove the toner cartridge.

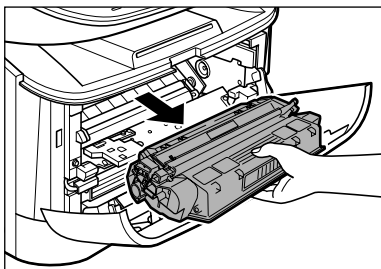

- 4** Insert the toner cartridge into the machine as far as it will go.

Hold the toner cartridge and align the protrusions (A) on both sides of the toner cartridge to the guides (B) in the machine, then gently slide the toner cartridge into the machine as far as it will go.

Be sure to position the arrow mark (C) on the toner cartridge towards the inside of the machine.

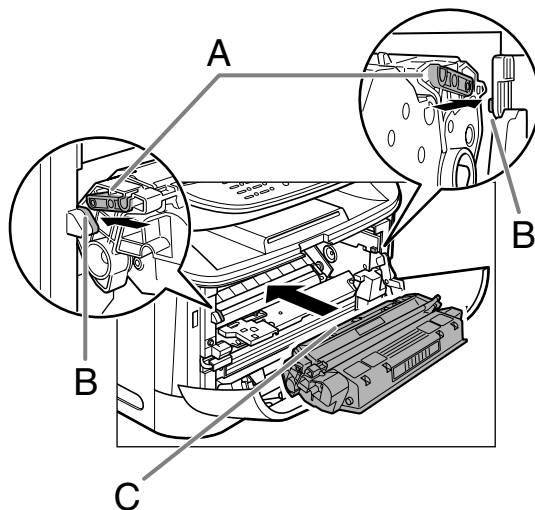

5 Close the front cover.

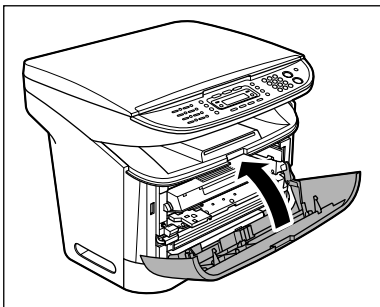

CAUTION

Be careful not to get your fingers caught.

Replacing the Toner Cartridge with a New One

1 Open the front cover.

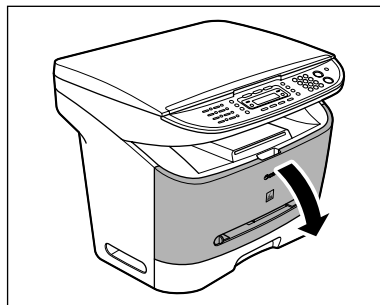

2 Remove the toner cartridge.

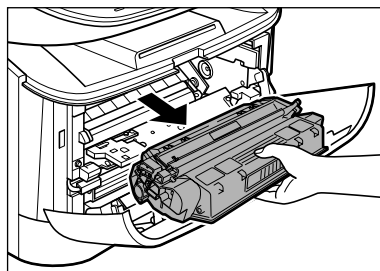

CAUTION

Do not open the drum protective shutter on the toner cartridge. Print quality may deteriorate if the drum surface is exposed to light or is damaged.



- 3** Remove the new toner cartridge from the protective bag.

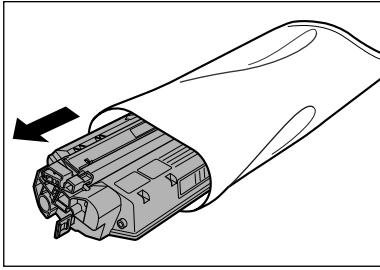

NOTE

Save the protective bag. You may need it later when you remove the toner cartridge from the machine.

- 4** Gently rock the toner cartridge five or six times to distribute toner inside.

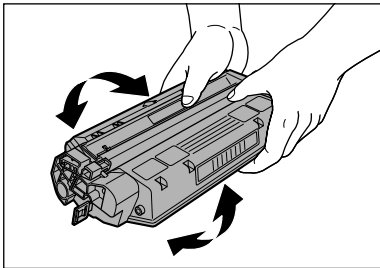

- 5** Place the toner cartridge on a flat and stable surface. Fold the tab (A) on the sealing tape (B) as shown below, and pull it out straight while supporting the toner cartridge.

Make sure that the tab itself is detached from the toner cartridge.

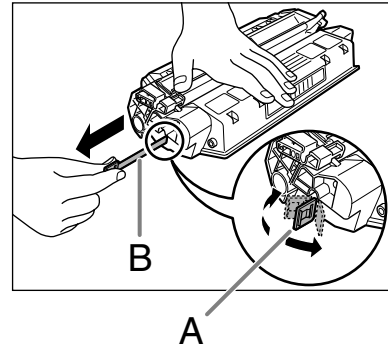

NOTE

To avoid breaking the tape, do not pull out the tape at an upward or downward angle.

6 Insert the toner cartridge into the machine as far as it will go.

Hold the toner cartridge and align the protrusions (A) on both sides of the toner cartridge to the guides (B) in the machine, then gently slide the toner cartridge into the machine as far as it will go.

Be sure to position the arrow mark (C) on the toner cartridge towards the inside of the machine.

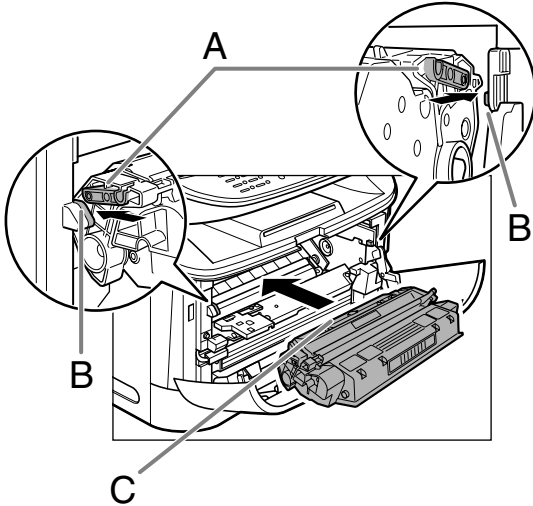

7 Close the front cover.

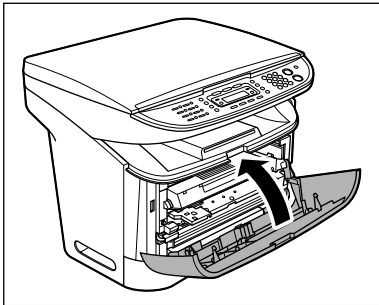

CAUTION

Be careful not to get your fingers caught.

Transporting the Machine

Follow this procedure to avoid vibration damage to the machine when transporting it over a long distance.

1 Disconnect the power cord and all the cables from the back of the machine.

2 Open the front cover.

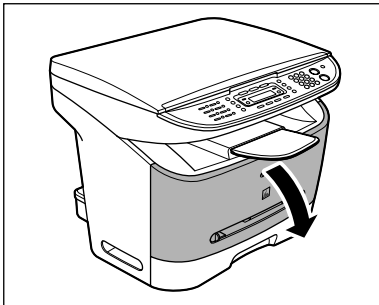

3 Remove the toner cartridge.

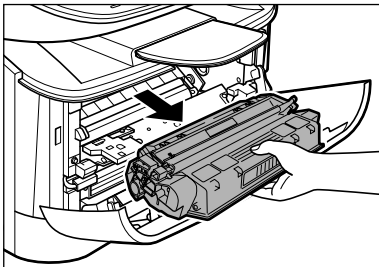

⚠ CAUTION

- To avoid exposing the toner cartridge to light, place it in its protective bag or wrap it in a thick cloth.
- Do not open the drum protective shutter on the toner cartridge. Print quality may deteriorate if the drum surface is exposed to light or is damaged.

4 Close the front cover.

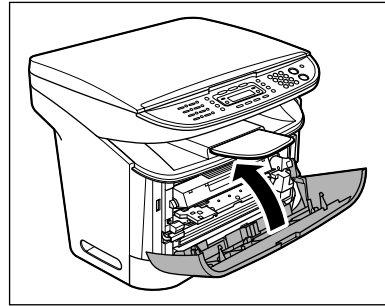

⚠ CAUTION

Be careful not to get your fingers caught.

5 Pull out the paper cassette completely, and remove the paper.

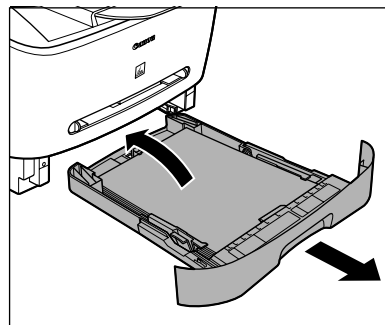

- 6** Remove the extension cover from the machine.

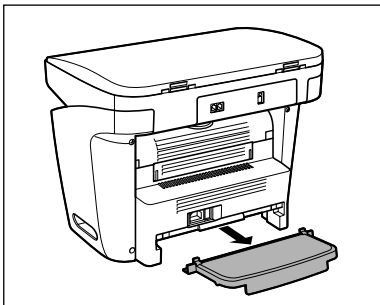

- 7** Detach the paper cassette extension from the paper cassette.

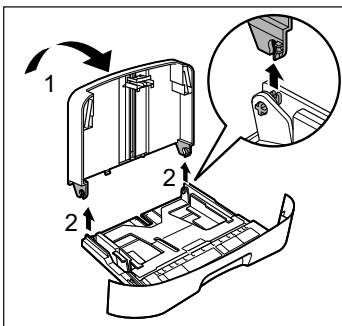

- 8** Insert the paper cassette into the machine.

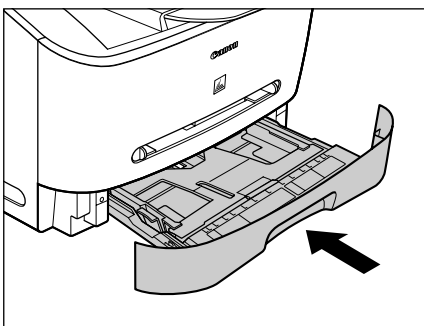

- 9** Detach the output tray.

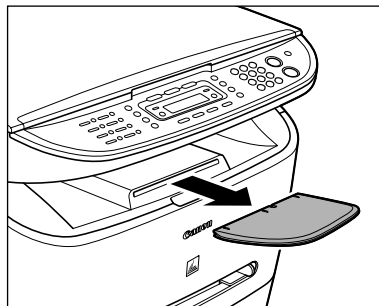

- 10** Make sure all the covers are closed.

- 11** Grip the handles on both sides of the machine and lift it carefully, as shown in the illustration below.

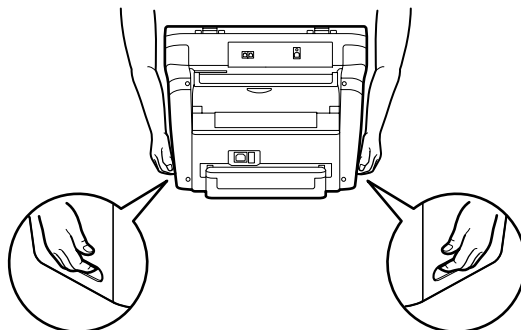

CAUTION

- Do not lift the machine by any of its attachments. Dropping the machine can cause personal injury.
- If you have a back problem, make sure to check the weight of this machine before carrying. (See "Specifications," on p. 13-1.)

11

Troubleshooting

Clearing Paper Jams

When a jam occurs inside the machine, the paper jam message appears on the LCD display. When <PAPER JAM> appears on the LCD display, remove jammed paper from inside the machine first, then from the paper cassette if necessary. Check the following if you experience repeated paper jams:

- Fan and tap the paper stack on a flat surface before loading it in the machine.
- Check that the paper you are using meets the requirements for use. (See “Print Media,” on p. 3-1.)
- Make sure you have removed any scraps of paper from inside the machine.

NOTE

Do not force jammed paper out of the machine. Contact your local authorized Canon dealer or the Canon help line for assistance if needed.

- 1** Open the front cover.

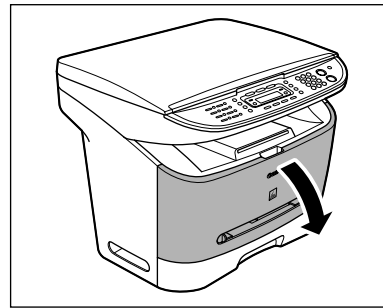

- 2** Remove the toner cartridge.

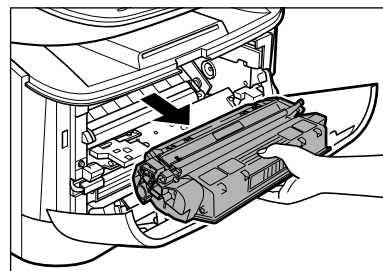

⚠ CAUTION

- Remove watches and any bracelets or rings when touching the inside of the machine. These items might be damaged if they come into contact with the parts inside the machine.
- To avoid possible damage to the machine, do not touch the pins (A) near the left end of the transfer roller (B).
- Do not open the drum protective shutter on the toner cartridge. Print quality may deteriorate if the drum surface is exposed to light or is damaged.

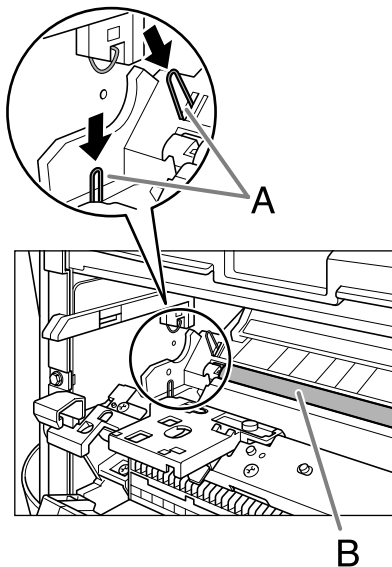

🚫 NOTE

Do not expose the toner cartridge to light for more than five minutes. If necessary, put the toner cartridge in its original protective bag or wrap it with a thick cloth to prevent exposure to light.

- 3** **Open the face up cover (A) and push down the green paper release levers (B) on both sides of the face up paper output area.**

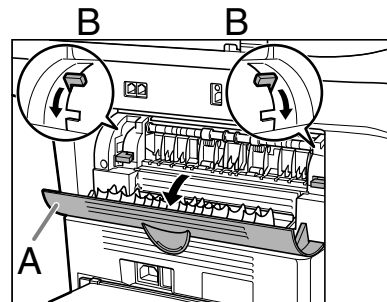

- When removing the jammed paper, do not touch the transfer roller as its surface is very delicate and susceptible to finger oil and scratches, which may lead to print deterioration.

4 Hold both sides of the jammed paper and carefully move it inward, then gently pull it out.

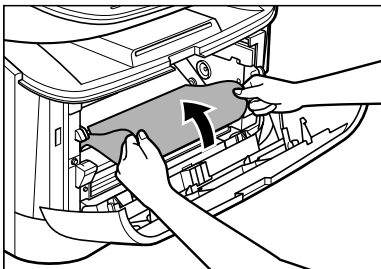

⚠ CAUTION

- When removing jammed paper, take care not to cut your hands on the edges of the paper.
- When removing jammed paper or when inspecting the inside of the machine, do not allow necklaces, bracelets, or other metal objects to touch the inside of the machine, as this may result in burns or electrical shock.
- If you tear the paper, remove any torn pieces to avoid further jams.
- If loose toner comes into contact with your skin or clothing, wash with cold water. Warm water will set the toner.

5 Gently pull the jammed paper out of the machine.

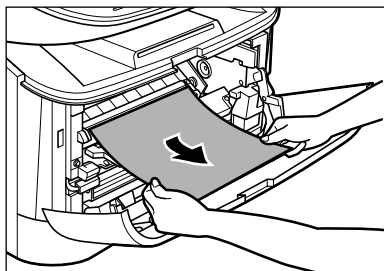

If the leading edge of the paper is visible but has not entered the imaging area, pull the paper forwards and roll it inwards.

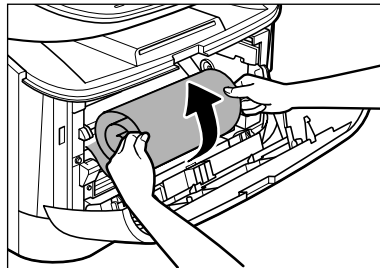

⚠ CAUTION

- Do not pull the jammed paper forward from the paper cassette. It may cause a machine malfunction.

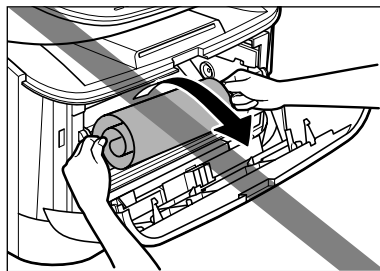
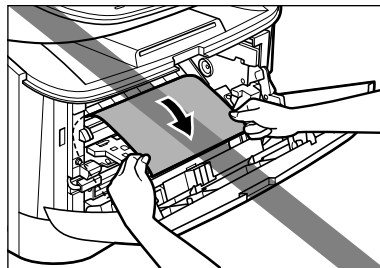

- Do not pull the jammed paper upward. The toner on the paper will stain the machine and cause a permanent reduction in print quality.

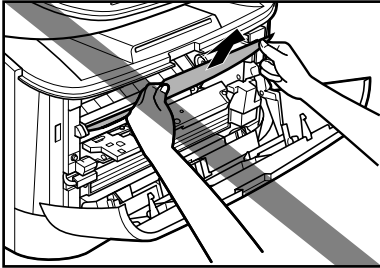

Jammed paper cleared → Go to Step 14
 Jammed paper Not cleared → Go to Step 6

- 6** Gently pull the jammed paper between the output rollers until the leading edge emerges from the machine.

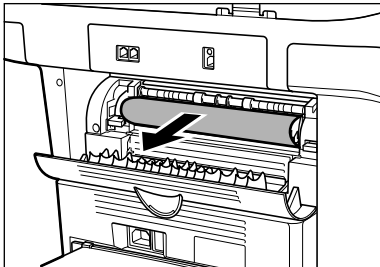

- 7** Carefully pull the jammed paper straight out through the rollers.

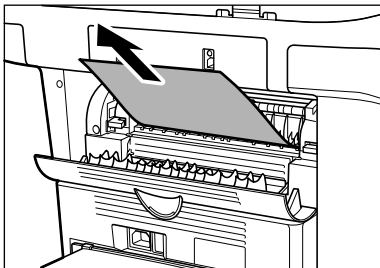

If the jammed paper is badly folded, similar to the folds of an accordion, ease the jammed paper loose and then pull it out of the machine.

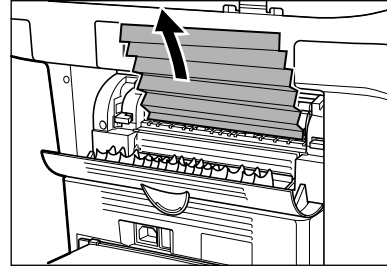

Jammed paper cleared → Go to Step 14
 Jammed paper Not cleared → Go to Step 8

- 8** Close the front cover.

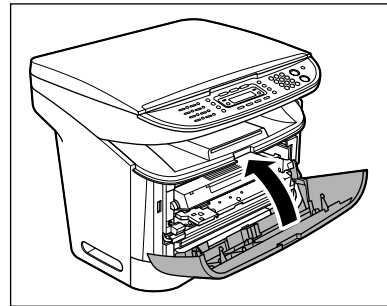

- 9** Pull out the paper cassette completely.

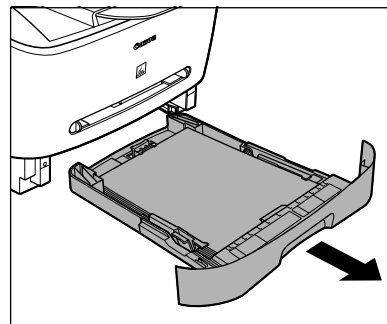

10 Hold both sides of the jammed paper and slowly pull it out in the direction of the arrow.

- When feeding paper from the paper cassette:

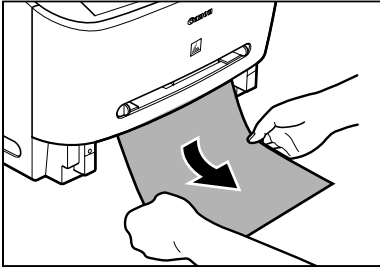

- When feeding paper from the multi-purpose feeder:

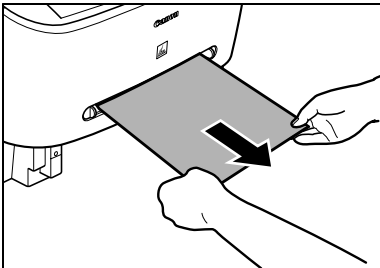

11 Push the green paper release levers (B) back to their original position and close the face up cover (A).

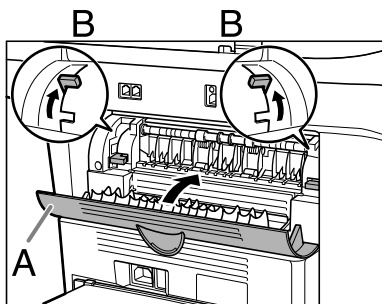

NOTE

- Be sure to push the paper release levers back to their original position. If the levers are left pushed down, the paper jam error will not be resolved.
- Never push down the paper release levers while printing. This could result in damage to the fixing assembly.

12 Insert the paper cassette to the machine.

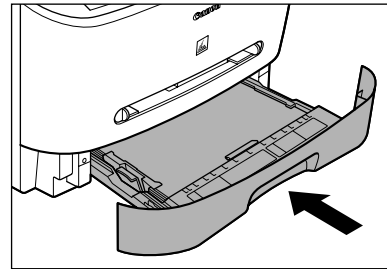

13 Open the front cover.

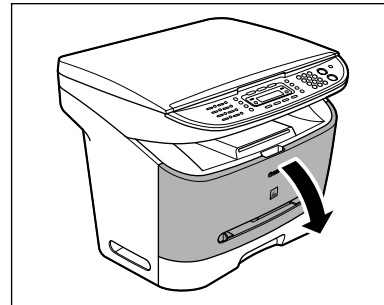

14 Insert the toner cartridge into the machine as far as it will go.

Hold the toner cartridge and align the protrusions (A) on both sides of the toner cartridge to the guides (B) in the machine, then gently slide the toner cartridge into the machine as far as it will go.

Be sure to position the arrow mark (C) on the toner cartridge towards the inside of the machine.

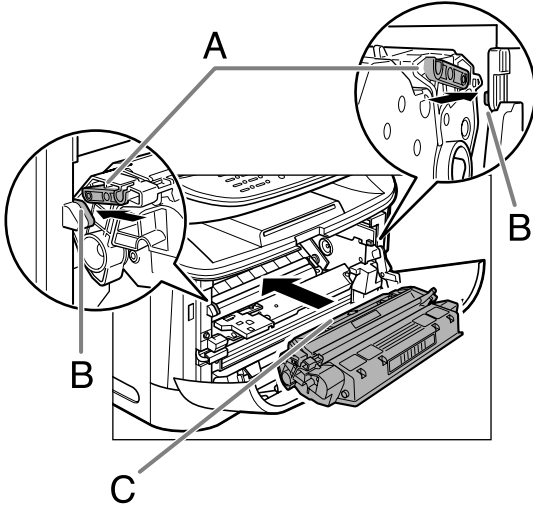

15 Close the front cover.

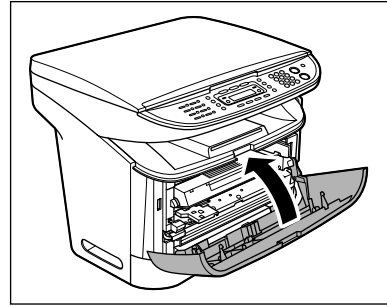

⚠ CAUTION

Be careful not to get your fingers caught.

🔧 NOTE

After you replace the toner cartridge and close the front cover, the machine should be ready for operating. If the machine returns to the ready state for operating, troubleshooting has been successful. If the machine does not return to the ready state for operating, confirm that the paper release levers are pushed back to their original position, and check to see that jammed paper is not left in the machine.

LCD Messages

See the table below when the LCD displays error messages.

Common

Message	Description	Action
CHANGE REG'D SIZE*	When the machine prints the reports or lists, the paper size is set to a size other than <A4> or <LTR>.	Set the paper size to <A4> or <LTR> and load paper of the same size. For the TX report or RX report, the machine automatically prints the report(s) which was stored in memory.
CHECK PRINTER	A problem has occurred in the printer.	Reset the machine by opening the front cover and then closing it. If the message persists, unplug the machine from the power supply and contact your local authorized Canon dealer or the Canon help line.
CLOSE COVER FRONT COVER	The front cover is not closed completely.	Check the front cover, and make sure that it is completely closed.

Message	Description	Action
LOAD CORRECT PAPER	The size of the paper in the paper cassette or multi-purpose feeder is different from that of the paper specified in <CASSETTE> or <MP TRAY> of the <PAPER SETTINGS> menu.	<ul style="list-style-type: none"> – Load the correct paper size or change the paper size in <CASSETTE> or <MP TRAY> of the <PAPER SETTINGS> menu. For more information, see “Setting Paper Size and Type,” on p. 3-7. – If you are trying to print a report or list, set the paper size to <A4> or <LTR> and load paper of the same size. <p>Then reset the machine by opening the front cover and then closing it.</p>
LOAD PAPER	No paper is loaded in the paper cassette or multi-purpose feeder, or not inserted correctly.	<p>Load paper in the paper cassette or multi-purpose feeder. (See “Loading Paper,” on p. 3-4.) Make sure the paper stack in the paper cassette does not exceed the capacity of the paper cassette.</p> <p>Load paper in the multi-purpose feeder one by one. If you load paper while making copies, do not load a different paper size.</p> <p>On the second line in the LCD the message <CASSETTE> or <MP TRAY> and the paper size may appear. In this case, load the corresponding paper in the paper cassette or multi-purpose feeder.</p>



Message	Description	Action
LOST IMAGE*	The data in memory was lost when the machine was turned on.	The error is automatically released after two seconds, and the machine automatically prints out the lost report that shows the records still existing in the activity report.
MEMORY FULL	<ul style="list-style-type: none"> – The number of the scanned document that can be stored in memory reached the maximum. – The machine's memory is full of scanned documents when you use the sort copy function. 	Divide the document and copy each part separately.
OUT OF TONER CHANGE TONER*	<ul style="list-style-type: none"> – The toner cartridge is almost empty. – If <CONT. PRINTING> is set to <OFF> in the <RX SETTINGS> of the <FAX SETTINGS> menu, the Fax printing and printing reports are interrupted when the <OUT OF TONER/CHANGE TONER> appears. 	<ul style="list-style-type: none"> – Replace with a new toner cartridge. – If you want to continue printing without replacing the toner cartridge, set <CONT. PRINTING> to <ON> in the <RX SETTINGS> of the <FAX SETTINGS> menu. However, the toner cartridge is almost empty, so you should replace the toner cartridge with a new one.
OUTPUT TRAY FULL*	The output tray is full of paper.	Remove the printouts from the output tray.

Message	Description	Action
PAPER JAM	Paper jams have occurred in the machine.	Clear the paper jam (See “Clearing Paper Jams,” on p. 11-1) and reload paper in the paper cassette or multi-purpose feeder. Then reset the machine by opening the front cover and then closing it.
PLEASE WAIT	This message appears when the power cord is plugged in or when the machine is not ready for printing.	Wait until the message disappears.
REMOVE MP PAPER*	Paper is loaded in the multi-purpose feeder.	Remove the paper from the multi-purpose feeder. The machine will not print faxes, reports, or lists when paper is loaded in the multi-purpose feeder. They will be stored in memory.
SYSTEM ERROR EXXX	A system error has occurred. <XXX> will be a three-digit code that indicates a particular type of error.	Unplug the machine. Wait for at least five seconds, and reconnect the power cord. If the message persists, contact your local authorized Canon dealer or the Canon help line.
TONER IS NOT SET INSERT THE TONER	A toner cartridge is not installed or not installed correctly.	Install the toner cartridge correctly. (See “Replacing the Toner Cartridge,” on p. 10-5.)
WRONG NUMBER ENTRY*	An invalid number was entered in the <DATE&TIME SETTING> of the <TIMER SETTINGS> menu.	Enter a correct date or time.

*MF3240 Only

Facsimile (MF3240 Only)

Message	Description	Action
ALREADY REGISTERED	The same recipient was entered twice.	Select a different recipient.
CANNOT REGIST MORE	<ul style="list-style-type: none">– Maximum number of recipients (123) were entered for broadcasting.– Maximum number of recipients (50) were registered for group dialing.	<ul style="list-style-type: none">– Resend the document to other recipients if necessary.– Register a different one-touch speed dialing key for group dialing.
HANG UP PHONE	External telephone is off the hook.	Hang up the phone.
LINE IS BUSY	The telephone line is busy or there was no answer.	Check if the recipient's number is correct or the telephone cable is properly connected.

Message	Description	Action
MEMORY FULL	<ul style="list-style-type: none"> – The memory becomes full during sending or receiving the fax. – The number of fax jobs that can be stored in memory reached the maximum. 	<ul style="list-style-type: none"> – When sending the document, divide it into a few parts or select a lower fax resolution. If you need more space, wait for the machine to send any remaining faxes. – The machine memory can store up to 256 fax jobs including sending and receiving jobs. (Based on the condition that the other party sends the fax by the imageCLASS MF3200 Series with ITU-T Standard Chart No.1, standard mode); Wait for the machine to send any faxes in memory. Also print or delete any documents in memory.
NOT AVAILABLE	<p>You pressed the one-touch speed dialing key that has already been registered, when you specify a one-touch speed dialing key as the group dial.</p>	<p>Check the information registered under the one-touch speed dialing before using.</p>



Message	Description	Action
NOT REGISTERED	No recipient is registered in the selected speed dialing key or code.	Select a registered key or code. For more information, “Registering One-Touch Speed Dialing,” on p. 4-7 or “Registering Coded Dialing,” on p. 4-14.
RECEIVED IN MEMORY	The received fax documents or the reports are in memory because paper or toner ran out, paper jams occurred, or incorrect paper size was loaded.	Load correct paper size in the paper cassette, replace the toner cartridge, or clear the paper jams. For more information, see the following: <ul style="list-style-type: none"> – “Loading Documents,” on p. 2-3. – “Replacing the Toner Cartridge with a New One,” on p. 10-6. – “Clearing Paper Jams,” on p. 11-1.
REGISTERING KEY CANNOT REGISTER	The selected one-touch speed dialing key is already used as the group dialing key it is being assigned to.	Select a different one-touch speed dialing key.

Printer

Message	Description	Action
PRINTER DATA ERROR CHECK PRINTER	The data from the PC was not printed.	Check if the software is installed properly or if the printer cable is properly connected.
PRINTING	The printer is processing a print job.	No action required. Wait for printing to finish.

Error Codes (MF3240 Only)

An error code is a four-digit code displayed on the LCD or in the bottom row of a TX Result Report or an RX Result Report when an error occurs.

Ex.

JOB NO.	TYPE	NO.	DESTINATION TEL/ID	DATE	TIME	PAGE	DURATION	MODE	RESULT
0001	TX	001	WEST-1 55555555	04/10	16:00	002	00h01min21s	ECM	NG
			00A0 TX CANCEL						

Error Code

For details on TX Result Report and RX Result Report, see Chapter 4, “Reports and Lists (MF3240 Only),” in the Advanced Guide.

See the table below for individual error codes.

Error Code	Description	Action
0001	The sender may not be using a G3 fax machine.	Make sure the sender's machine is compatible with your machine.
0070	Reception was manually canceled on the machine.	Ask the sender to resend the document if necessary.
0071	The machine's memory is full.	Print, send, or delete any documents stored in memory.
0080	The recipient's machine did not respond within 35 seconds.	Resend the document. Ask the other party to check their machine. If you are making an overseas call, add a pause to the number.
008D	The recipient's machine has run out of paper.	Ask the recipient to make sure that paper is loaded in their machine.
00A0	Transmission was manually canceled on the machine.	Resend the document if necessary.
00A1	There is a document jam.	Clear the document jam.
00FF	All redialing attempts have failed.	Check if the recipient's number is correct or the telephone cable is properly connected, and try again.

If You Cannot Solve a Problem

If you cannot solve the problem after having referred to the information in this chapter, contact your local authorized Canon dealer or the Canon help line.

Please have the following information ready when you contact Canon:

- Product name (imageCLASS MF3240/MF3222)
- Serial number (On the label located at the back of the machine)
- Place of purchase
- Nature of problem
- Steps you have taken to solve the problem and the results

CAUTION

If the machine makes strange noises, emits smoke or odd odor, unplug it immediately and contact your local authorized Canon dealer or the Canon help line. Do not attempt to disassemble or repair the machine yourself.

NOTE

Attempting to repair the machine yourself may void the limited warranty.

12 Machine Settings

Machine Settings

You can adjust the machine settings from the Setting Menu to customize the way the machine works. To see the list of current settings, print out User's Data List.

Printing User's Data List (MF3240 Only)

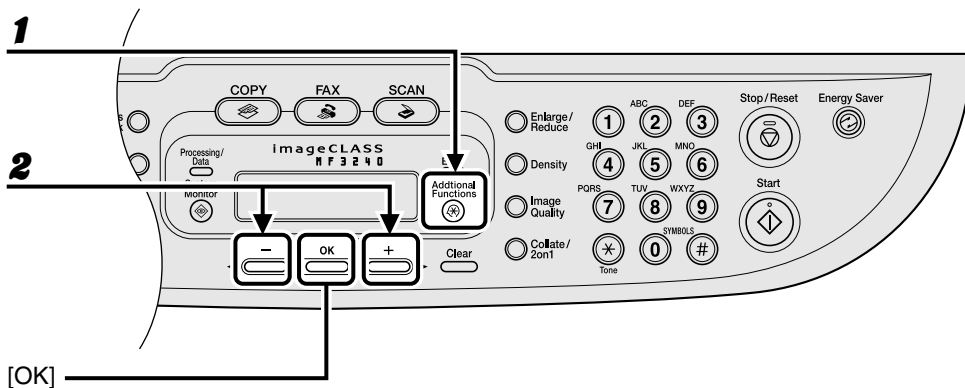

- 1** Press [Additional Functions].
- 2** Press [←] or [→] to select <REPORT SETTINGS>, then press [OK].

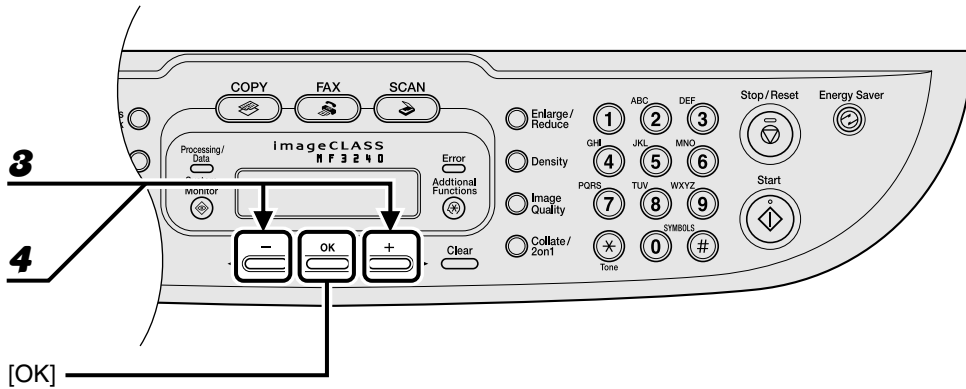

- 3** Press [**←**] or [**→**] to select <LIST PRINT>, then press [OK].
- 4** Press [**←**] or [**→**] to select <USER'S DATA LIST>, then press [OK].

Accessing the Setting Menu

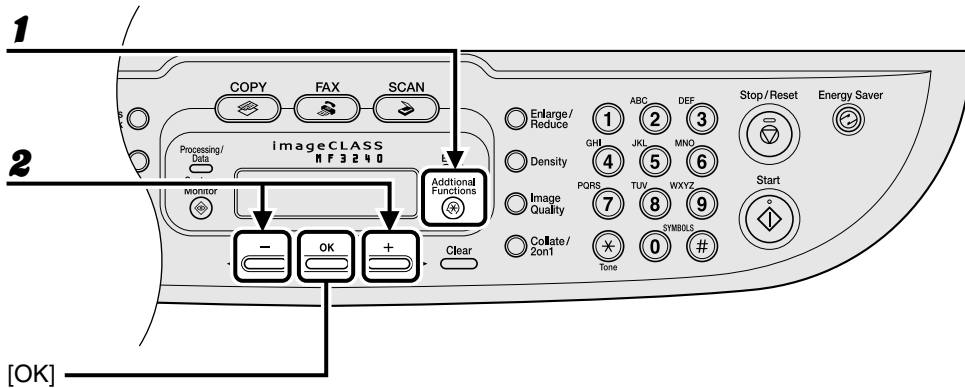

1 Press [Additional Functions].

2 Press [←] or [→] to select the menu you want to access, then press [OK].

<COMMON SETTINGS>

<COPY SETTINGS>

<TIMER SETTINGS>

<FAX SETTINGS>*

<BROADCAST>*

<ADDRESS BOOK SET.>*

<REPORT SETTINGS>*

* MF3240 Only

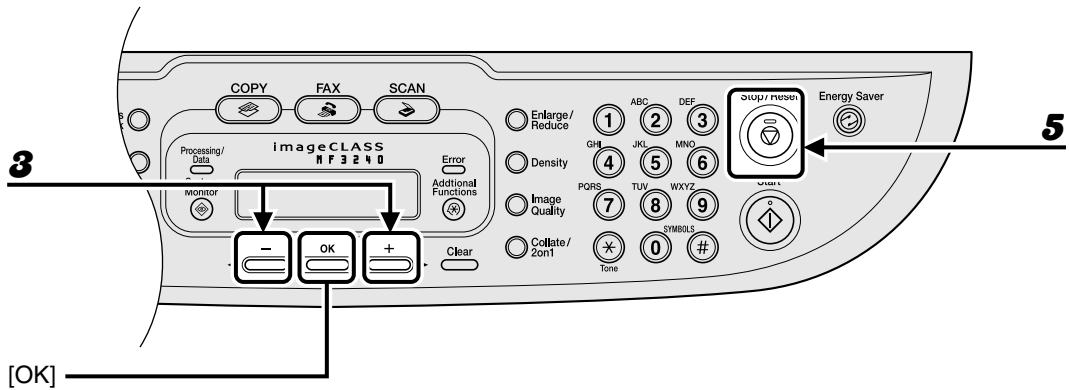

- 3** Press [◀-] or [+▶] to select a submenu, then press [OK].
- 4** To register the settings or go to a submenu item, press [OK].
- 5** When finished, press [Stop/Reset] to return to standby mode.

 **NOTE**

Press [Stop/Reset] to exit from the menu. If you press [Stop/Reset] before pressing [OK], the setting will not be registered.

Setting Menu

NOTE

- Depending on the country of purchase, some settings may not be available.
- The menus described in this section are based on the model imageCLASS MF3240. Depending on the model of your machine, some settings may not be available and the number on the top of each menu may vary.

COMMON SETTINGS	
Setting Item	Description
1 DEFAULT SETTINGS	Selects which standby display appears when the power cord is plugged. <ul style="list-style-type: none">– COPY– FAX*– SCAN
2 TONER SAVER MODE	Sets whether to reduce toner consumption. <ul style="list-style-type: none">– OFF– ON
3 PAPER SETTINGS	Sets the paper type and size on the paper cassette or multi-purpose feeder. (See “Setting Paper Size and Type,” on p. 3-7.)
CASSETTE	Sets the paper size and type for the paper cassette.
MP TRAY	Sets the paper size and type for the multi-purpose feeder.
4 DISPLAY LANGUAGE	Selects the language on the display. (See “Specifications,” on p. 13-1.)

COMMON SETTINGS	
5 AUDIBLE TONES*	Sets volumes for machine beeps in four levels. – MID – HIGH – OFF – LOW
CALLING TONE	Sets the calling volume.
ENTRY TONE	Sets the keypad volume.
ERROR TONE	Sets the alarm volume.
MONITOR VOL. CTRL	Sets the line monitor volume.

*MF3240 Only

COPY SETTINGS	
Setting Item	Description
1 DENSITY	Sets the density for copying. – MANUAL (1-9) – AUTO* * When <AUTO> is set, Image Quality mode is automatically set to <TEXT>.
2 IMAGE QUALITY	Sets the document type for copying. – TEXT – PHOTO* – TEXT/PHOTO* * When <PHOTO> or <TEXT/PHOTO> is set, Density mode is automatically set to <MANUAL>.
3 AUTO COLLATE	Sets whether to collate the copies automatically. – OFF – ON
4 PAPER SIZE GROUP	Selects a paper size group for your machine.* – AB – INCHES – A * If the paper size group is changed, the available preset copy ratios will also change.

TIMER SETTINGS	
Setting Item	Description
1 AUTO SLEEP	Sets auto sleep mode when the machine remains idle for a certain period of time. (3MIN.-30MIN.) (See “Setting Sleep Mode,” on p. 1-10.) – ON – OFF
2 DATE&TIME SETTING*	Sets the current date and time. (See “Set the Date and Time (MF3240 Only),” in the Starter Guide.)
3 DATE TYPE SELECT*	Sets the date format. – DD/MM YYYY – YYYY MM/DD – MM/DD/YYYY
4 DAYLIGHT SV. TIME*	Sets daylight saving time mode. (See “Setting Daylight Saving Time (MF3240 Only),” on p. 1-13.) – ON – OFF

*MF3240 Only

FAX SETTINGS (MF3240 Only)	
Setting Item	Description
1 COMMON SETTINGS	Registers your fax number, name, and country.
UNIT TELEPHONE #	Registers your fax number. (See “Set the Machine for Sending Faxes (MF3240 Only),” in the Starter Guide.)
UNIT NAME	Registers your name/company name. (See “Set the Machine for Sending Faxes (MF3240 Only),” in the Starter Guide.)
2 TX SETTINGS	Sets the transmission functions.
DENSITY	Sets the default density for faxing. (1-3)

FAX SETTINGS (MF3240 Only)

IMAGE QUALITY	<p>Sets the default image quality for faxing.</p> <ul style="list-style-type: none"> – STANDARD – FINE – PHOTO – SUPER FINE
AUTO REDIAL	<p>Sets whether to redial automatically when the other line is busy or a transmission error occurs. (See Chapter 1, “Advanced Fax Features (MF3240 Only),” in the Advanced Guide.)</p>
ON	<p>Customizes the redial operation.</p>
REDIAL TIMES	<p>Sets the number of retries. (1 TIMES-10 TIMES)</p>
REDIAL INTERVAL	<p>Sets period of time before redialing. (2 MIN.-99 MIN.)</p>
OFF	<p>After the first attempt at dialing fails, redialing is not attempted.</p>
TX TERMINAL ID	<p>Sets whether to show the sender information on each page sent.</p> <ul style="list-style-type: none"> – ON* – OFF <p>*When <ON> is set, the information registered in <UNIT TELEPHONE #> and <UNIT NAME> are shown on each page sent.</p>
DIALING LINE CHCK	<p>Sets whether to check the telephone line condition.</p> <ul style="list-style-type: none"> – OFF – ON



FAX SETTINGS (MF3240 Only)	
3 RX SETTINGS	Sets the reception functions.
INCOMING RING	Sets whether the telephone rings when it receives a voice call, enabling you to answer the call. This function is only available when the <RX MODE> is set to <FaxOnly>.
OFF	The telephone does not ring when it receives a voice call.
ON	The telephone rings when it receives a voice call if an external telephone is connected.
RING COUNT	Sets the number of incoming ring before the machine answers. (1 TIMES-16 TIMES)
RX REDUCTION	Sets whether to reduce or truncate the image when a faxed page is larger than the size of paper loaded. (See Chapter 1, "Advanced Fax Features (MF3240 Only)," in the Advanced Guide.)
ON	Reduces the image to fit on the size of paper loaded.
OFF	Retains the original size of the image.
CUT	The image that is larger than 1-page record area is cut and not recorded.
RX PRINT	Sets whether to store all received pages in memory before printing them out or print each page as it is received. (See Chapter 1, "Advanced Fax Features (MF3240 Only)," in the Advanced Guide.)
MEMORY RX	Print after all the pages of the document are received.
PRINT RX	Print each page as it is received.
RX MODE	<p>Selects receive mode. (See "Set the Machine for Receiving Faxes (MF3240 Only)," in the Starter Guide.)</p> <ul style="list-style-type: none"> – FaxOnly – AnsMode – NET SWITCH – FaxTel – MANUAL

FAX SETTINGS (MF3240 Only)	
RX TERMINAL ID	Sets whether to insert the machine's fax number and the sender information on received faxes. – OFF – ON
RX RESTRICTION	Sets whether to receive a fax by detecting the TSI (Transmitting Subscriber Identification) signal, used to identify the sending fax machine. (See Chapter 1, "Advanced Fax Features (MF3240 Only)," in the Advanced Guide.)
OFF	All receptions are conducted.
ON	Receives the fax only from the sending fax machine that sends the TSI signal.
REMOTE RX	Sets whether to use remote receiving. (See Chapter 1, "Advanced Fax Features (MF3240 Only)," in the Advanced Guide.) – ON – OFF
CONT. PRINTING	Sets whether to stop printing when toner has run out. This function is only for Fax printing and printing reports. – OFF – ON
4 COMMUNICATIONS	Sets the communication setting.
TEL LINE TYPE	Selects the telephone line type. (See "Set the Machine for Sending Faxes (MF3240 Only)," in the Starter Guide.)
TOUCH TONE	The telephone line is set for touch tone dialing.
ROTARY PULSE	The telephone line is set for rotary pulse dialing.
R-KEY SETTING	Registers the [R] key to access an outside line easily. (See Chapter 1, "Advanced Fax Features (MF3240 Only)," in the Advanced Guide.) – PSTN – PBX

BROADCAST (MF3240 Only)	
Setting Item	Description
BROADCAST	Registers destinations for broadcasting.

ADDRESS BOOK SET. (MF3240 Only)	
Setting Item	Description
1 1-TOUCH SPD DIAL	Registers the information on one-touch speed dialing. Up to 7 destinations can be registered. (See “Registering One-Touch Speed Dialing,” on p. 4-7.)
NAME	Registers the recipient’s name (max. 20 characters, including spaces).
TEL NUMBER ENTRY	Registers the recipient’s fax number (max. 50 digits, including spaces).
2 CODED DIAL	Registers the information on coded dialing. Up to 100 destinations can be registered. (See “Registering Coded Dialing,” on p. 4-14.)
NAME	Registers the recipient’s name (max. 20 characters, including spaces).
TEL NUMBER ENTRY	Registers the recipient’s fax number (max. 50 digits, including spaces).
3 GROUP DIAL	Registers the information on group dialing. Up to 50 destinations can be registered. (See “Registering Group Dialing,” on p. 4-21.)
NAME	Registers the group name (max. 20 characters, including spaces).

REPORT SETTINGS (MF3240 Only)	
Setting Item	Description
1 SETTINGS	Sets the report functions. (See Chapter 4, "Reports and Lists (MF3240 Only)," in the Advanced Guide.)
TX RESULT REPORT	Sets whether the fax transmission report prints out. – PRINT ERROR ONLY – OUTPUT NO – OUTPUT YES
RX RESULT REPORT	Sets whether the fax reception report prints out. – OUTPUT NO – OUTPUT YES – PRINT ERROR ONLY
ACTIVITY REPORT	Sets whether to automatically print the fax transaction report. – OUTPUT YES – OUTPUT NO
2 LIST PRINT	Prints reports/lists.
TX RESULT REPORT	Prints the fax transmission report manually.
RX RESULT REPORT	Prints the fax reception report manually.
ACTIVITY REPORT	Prints the fax transaction report manually.
MEMORY DATA LIST	Prints the list of the reserved jobs in memory.
MEMORY IMAGE PRNT	Prints the information and image of the first page of the reserved job.
1-TOUCH LIST	Prints the list of fax/telephone numbers and names registered for one-touch speed dialing.
CODED DIAL LIST	Prints the list of fax/telephone numbers and names registered for coded dialing.
GROUP DIAL LIST	Prints the list of groups registered for group dialing.
USER'S DATA LIST	Prints the setting list registered in the menu. (See "Printing User's Data List (MF3240 Only)," on p. 12-1.)

13 Appendix

Specifications

General	
● Type	Personal Desktop
● Power Source	220-240V, 50/60 Hz (Power requirements differ depending on the country in which you purchased the product.)
● Power Consumption	MF3240: Max: Approx. 780 W Working: Less than 390 Wh Standby: Less than 9.5 Wh Energy Saver Mode: Less than 5.0 Wh MF3222: Max: Approx. 780 W Working: Less than 390 Wh Standby: Less than 8.0 Wh Energy Saver Mode: Less than 5.0 Wh
● Warm-up Time	Less than 8 sec.* (temperature: 20°C, humidity: 65%; from when the power cord is plugged in the AC outlet until standby display appears) * Warm-up time may differ depending on the condition and environment of the machine.
● Weight	MF3240: Approx. 11 kg (including toner cartridge) MF3222: Approx. 10.8 kg (including toner cartridge)

General	
● Dimensions	449 mm (W) × 487 mm (D) × 369 mm (H) (with the paper cassette attached) 449 mm (W) × 539 mm (D) × 369 mm (H) (with the paper cassette attached and front cover opened)
● Installation Space	649 mm (W) × 984 mm (D)
● Environmental Conditions	Temperature: 15°C–30°C Humidity: 10%–80% RH
● Display Languages	ENGLISH / GERMAN / FRENCH / SPANISH / ITALIAN / SWEDISH / NORWEGIAN / DUTCH / FINNISH / DANISH / PORTUGUESE / CZECH / SLOVENE / HUNGARIAN / RUSSIAN / TURKISH
● Acceptable Documents	» p. 2-1.
● Acceptable Paper Stock	» p. 3-1.
● Printable Area	» p. 3-2.
● Scanning Area	» p. 2-2.

Copier	
● Scanning Resolution	Text mode: 600 dpi × 400 dpi Photo mode, Text/Photo mode: 600 dpi × 600 dpi
● Printing Resolution	600 dpi × 600 dpi
● Magnification	1 ± 1.0%, 1:2.00, 1:1.41, 1:1.22, 1:1.15, 1:0.86, 1:0.81, 1:0.70, 1:0.50 Zoom 0.50 - 2.00, 1% increments
● First Copy Time	Less than 11 sec. (A4)
● Copy Speed	Direct: A4 20 cpm
● No. of Copies	Max. 99 copies

Printer	
● Printing Method	Indirect electrostatic method (On-demand fixing)
● Paper Handling	– Paper cassette: 250 sheets × 1 cassette (64 g/m ²) – Multi-purpose feeder: 1 sheet
● Paper Delivery	» p. 3-11.
● Print Speed	See “Copy Speed,” on p. 13-3.
● Printing Resolution	600 dpi × 600 dpi
● Number of Tones	256
● Printing Cartridge	» p. 1-8.

Facsimile (MF3240 Only)	
● Applicable Line	Public Switched Telephone Network (PSTN)* ¹
● Compatibility	G3
● Data Compression Schemes	MH, MR, MMR
● Modem Speed	33.6 Kbps Automatic fallback
● Transmission Speed	Approx. 3 seconds/page* ² at 33.6 Kbps, ECM-MMR, transmitting from the memory
● Transmission/ Reception Memory	Maximum approx. 256 pages* ² (total pages of transmission/reception)
● Fax Resolution	STANDARD: 8 pels/mm × 3.85 lines/mm FINE: 8 pels/mm × 7.7 lines/mm PHOTO: 8 pels/mm × 7.7 lines/mm SUPER FINE: 8 pels/mm × 15.4 lines/mm
● Dialing	<ul style="list-style-type: none"> – Speed dialing One-touch speed dialing (7 destinations) Coded dialing (100 destinations) Group dialing (50 destinations) Address Book dialing (with Address Book key) – Regular dialing (with numeric keys) – Automatic redialing – Manual redialing (with Redial/Pause key) – Sequential broadcast (123 destinations) – Automatic reception – Remote reception by telephone (Default ID: 25) – ACTIVITY REPORT (after every 60 transactions) – TX (Transmission)/RX (Reception) REPORT – TTI (Transmit Terminal Identification)

Telephone (MF3240 Only)

● Connection	– External telephone/answering machine (CNG detecting signal)/data modem
---------------------	--

*1 The Public Switched Telephone Network (PSTN) currently supports 28.8 Kbps modem speed or lower, depending on telephone line conditions.

*2 Based on ITU-T Standard Chart No. 1, MMR standard mode.

 **NOTE**

Specifications are subject to change without notice.

A

[Additional Functions] key 1-4

[Address Book] key 1-6

ADDRESS BOOK SET. 12-3, 12-11

B

BROADCAST 12-3, 12-11

C

CHANGE TONER message 10-5

Cleaning machine 10-1

Exterior 10-1

Interior 10-2

Scanning area 10-4

[Clear] key 1-4

Clearing Paper Jams 11-1

[Coded Dial] key 1-6, 4-31

Coded dialing 4-6

Deleting 4-19

Editing 4-16

Registering 4-14

Using 4-31

[Collate/2 on 1] key 1-4

COMMON SETTINGS 12-3, 12-5

[COPY] key 1-3

COPY SETTINGS 12-3, 12-6

Copying 6-1

D

Daylight saving time 1-13

Density

Copying 6-4

Faxes 4-5

[Density] key 1-3

Document

Loading 2-3

Requirements 2-1

Scanning area 2-2

E

[Energy Saver] key 1-3

[Enlarge/Reduce] key 1-3

Error codes 11-15

Error indicator 1-3

Extension cover 1-2

External device jack 1-2

F

Face down paper output area 3-12

Face up cover 1-2

Face up paper output area 3-13

[FAX] key 1-3

FAX SETTINGS 12-3, 12-7

Faxes

Receiving 5-1

Sending 4-1

Front cover 1-1

G

Group dialing 4-6

- Adding destination 4-23
- Changing name 4-26
- Deleting destination 4-24
- Deleting group 4-28
- Registering 4-21
- Using 4-30

H

[Hook] key 1-6

I

If You Cannot Solve a Problem 11-16

Image quality

- Copying 6-3
- Faxes 4-3

[Image Quality] key 1-4

L

LCD 1-4, 1-7

- Messages 11-7

Loading

- Document 2-3
- Envelopes 3-4
- Paper 3-4

M

Machine Components 1-1

Machine settings 12-1

Maintenance 10-1

Menu

- Accessing 12-3
- Setting 12-5

Multi-purpose feeder 1-1, 3-4

N

Numeric keys 1-3

O

[OK] key 1-4

One-Touch Speed Dial keys 1-6

One-touch speed dialing 4-6

- Deleting 4-12
- Editing 4-9
- Registering 4-7
- Using 4-30

Operation panel 1-1, 1-3

Output tray 1-1

P

Paper

- Guidelines 3-3
- Loading 3-4
- Printable area 3-2
- Requirements 3-1

Paper cassette 1-1

Paper type and paper output area 3-11

PC Faxing 9-1

Platen glass 1-1

Platen glass cover 1-1

Power socket 1-2

Printing 7-1

Processing/Data indicator 1-3

R

Receiving faxes 5-1

[Redial/Pause] key 1-6

Redistributing toner 10-5

Registering speed dialing 4-6

Replacing toner cartridge 10-5

REPORT SETTINGS 12-3, 12-12

RX SETTINGS 12-9

S

- [SCAN] key 1-3
- Scan settings
 - Copying 6-3
 - Faxes 4-3
- Scanning 8-1
- Selecting the paper output area 3-10
- Sending faxes 4-1
- Setting paper size and type 3-7
- Sleep Mode 1-10
- Specifications 13-1
 - Copier 13-3
 - Facsimile 13-4
 - General 13-1
 - Printer 13-3
 - Telephone 13-5
- Speed dialing 4-6
- Standby mode
 - Copy 1-7
 - Fax 1-7
 - Scan 1-7
- [Start] key 1-3
- [Stop/Reset] key 1-3
- [System Monitor] key 1-4

T

- Telephone line jack 1-2
- TIMER SETTINGS 12-3, 12-7
- Timer settings 1-10
- [Tone] key 1-4
- Toner cartridge 1-8
 - Replacing 10-6
- Transporting machine 10-9
- Troubleshooting 11-1
- TX SETTINGS 12-7

U

- USB port 1-2
- User's Data List 12-1
 - Printing 12-1
- Using speed dialing 4-30

Z

- Zoom ratio 6-6
 - Preset zoom 6-6
 - Zoom designation 6-7



CANON INC.

30-2, Shimomaruko 3-chome, Ohta-ku, Tokyo 146-8501, Japan

CANON U.S.A., INC.

One Canon Plaza, Lake Success, NY 11042, U.S.A.

CANON CANADA INC.

6390 Dixie Road Mississauga, Ontario L5T 1P7, Canada

CANON EUROPA N.V.

Bovenkerkerweg 59-61 1185 XB Amstelveen, The Netherlands

CANON FRANCE S.A.S.

17, quai du Président Paul Doumer 92414 Courbevoie Cedex, France

CANON COMMUNICATION & IMAGE FRANCE S.A.S.

12, rue de l'Industrie 92414 Courbevoie Cedex, France

CANON (U.K.) LTD.

Woodhatch, Reigate, Surrey, RH2 8BF, United Kingdom

CANON DEUTSCHLAND GmbH

Europark Fichtenhain A10, 47807 Krefeld, Germany

CANON ITALIA S.p.A.

Via Milano, 8 20097 San Donato Milanese (MI) Italy

CANON ESPAÑA, S.A.

c/ Joaquín Costa 41, 28002 Madrid, Spain

CANON LATIN AMERICA, INC.

703 Waterford Way Suite 400, Miami, Florida 33126 U.S.A.

CANON AUSTRALIA PTY. LTD

1 Thomas Holt Drive, North Ryde, Sydney, N.S.W. 2113, Australia

CANON CHINA CO., LTD

15F, North Tower, Beijing Kerry Centre, 1 Guang Hua Road, Chao Yang District, 100020, Beijing, China

CANON SINGAPORE PTE. LTD.

1 HarbourFront Avenue #04-01 Keppel Bay Tower, Singapore 098632

230V